



# Omnia-5EX

HD + FM  
Broadcast Audio Processor

*Installation and Operation Manual*

Version 1.1e / April 2004

Applicable to v5.0.1 FM Release Software and Higher



Omnia • 2101 Superior Avenue Cleveland, Ohio 44114 USA  
TEL: +1 216.241.7225 • FAX: +1 216.241.4103 • Email [info@omniaaudio.com](mailto:info@omniaaudio.com) [www.omniaaudio.com](http://www.omniaaudio.com)

Omnia Europe • Johannstrabe 6 D-85354 Freising Germany  
TEL: +49 8161 42467 • FAX +49 8161 42402 • Email: [europe@omniaaudio.com](mailto:europe@omniaaudio.com) [www.omniaaudio.com](http://www.omniaaudio.com)

February, 2004

Greetings!

It's with great pleasure to offer you our latest audio processor...Omnia-5EX! First and foremost, I must share my gratitude as well. This new addition, continues the evolution of Omnia processing. The worldwide acceptance of our product line has been quite humbling, to say the least. As I write this, our processors are now deployed by so many leading broadcasters throughout the world that when looking at the list, I am overwhelmed by the recognition that my (originally small) project to improve the sound of radio has gathered. So, it's to you I say...*Thank You!*

1986 seems like just a short time ago! It was that year, in the engineering shop at Z-100, (WHTZ-FM) New York City that our first product was born...*The Vigilante FM Limiter*. Now, 16 years later, along with an incredibly talented team of fellow broadcasters and engineers, we offer you a feature rich, and sonically powerful tool in Omnia-5EX! This processor is not just Frank anymore. It's a complex effort from a tremendous team that has had only *one* goal in mind...to raise the bar, *yet again*, and present you with our best effort possible.

I don't have enough space here to thank each and every one of the Telos/Omnia worldwide team members who have contributed to this product in so many important ways. All I can say is that we would not be where we are without the heroic and brilliant efforts from all of you working together. It's our goal to set the standard by which all others will be judged. The rules have changed, and Omnia processing is the reason why! What was once a truly small company consisting of only my cat Vito and myself has now expanded to the point of having the *best* talent in every area of product design, engineering, and marketing. (Not to mention, we now have the vital assistance of *three* cats...*Omnia*, *Zephyr*, and *Mocha*.)

If I may say so, our pool of engineers for DSP development and software design is probably the finest in the radio industry. My partner in crime, Steve Church, brought DSP into the broadcasting field in the mid-1980's and we've been strengthening our abilities ever since. Sharing Telos' ingenuity for DSP design has been tremendously beneficial to our work on Omnia. If you thought the original Omnia made noise on the dial, all I can say is "look out!" It's like one of the top-of-the hour station ID's Scott Shannon used to jam on Z-100...*"Lock It In And Rip The Knob Off!"* That's the kind of power and capability Omnia-5EX delivers!

As HD-Radio evolves, it is worth mentioning that our organization Telos and Omnia were involved *behind the scenes* with the IBOC developers. Our extensive background in both dynamics processing and audio codecs assisted iBiquity with development of their system. We were some of those involved to help them understand the need for a better codec for the AM system, which they have implemented. As a small reminder, it was the efforts of our Steve Church who introduced the USA to MP3, which has now evolved into aac. Modestly speaking, no other processing developer has the synergy of being on the leading edge of coding and dynamics.

Before signing off, I would be remiss not to mention one individual though...Jeff Keith, the leader of Team Omnia. Jeff is quite well known in his own right as an audio processing *guru!* His years of radio station experience and vast processing knowledge have dominated many a radio market, and now his efforts are an added benefit to Omnia-5EX. His creativity, passion and commitment to our success has helped all the various talented (and sometimes chaotic) crew unite in a common goal. To build a processor so great, it would surpass even *my* high expectations. Jeff, you and your team have succeeded! Thus, I dedicate Omnia-5EX to you!

Not only do you have in your possession the best sounding audio processor available, you also have the full support of our organization. If you have something to say, we're here to listen. We've been fortunate through the past, that people like you have taken the time to offer us valuable feedback and review of our endeavors. You can now see the result of that, as you are now rewarded with the next step forward!

Without further adieu, it's time for us to jam! So, as my buddy Scott Shannon would often say to me, "*Frank-o, Let's Crank It Up Man!*"

Here's to Dial Dominance,



Frank Foti

# SAFETY INSTRUCTIONS

1. **Read All Instructions.** All safety and operating instructions must be read before operating the product.
2. **Retain All Instructions.** All safety and operating instructions must be retained for future reference.
3. **Heed All Warnings.** All warnings on the product and those listed in the operating instructions must be adhered to.
4. **Follow All Instructions.** All operating and product usage instructions must be followed.
5. **Heat.** This product must be situated away from any heat sources such as radiators, heat registers, stoves, or other products (including power amplifiers) that produce heat.
6. **Ventilation.** Slots and openings in the product are provided for ventilation. They ensure reliable operations of the product, keeping it from overheating. These openings must not be blocked nor covered during operation. This product should not be placed into a rack unless proper ventilation is provided through following the manufacturer's installation procedures.
7. **Water and Moisture.** Do not use this product near water – for example; near a bath tub, wash bowl, kitchen sink or laundry tub; in a wet basement; or near a swimming pool or the like.
8. **Attachments.** Do not use any attachments not recommended by the product manufacturer as they may cause hazards.
9. **Power Sources.** This product must be operated from the type of power source indicated on the marking label and in the installation instructions. If you are not sure of the type of power supplied to your facility, consult your local power company.
10. **Grounding and Polarization.** This product is equipped with a polarized AC plug with integral safety ground pin. Do not defeat the safety ground in any manner.
11. **Power Cord Protection.** Power supply cords must be routed so that they are not likely to be walked on nor pinched by items placed upon or against them. Pay particular attention to the cords at AC wall plugs and convenience receptacles, and at the point where the cord connects to the product.
12. **Lightning.** For added protection for this product during a lightning storm, or when it is left unattended and unused for long periods of time, unplug it from the AC wall outlet. This will prevent damage to the product due to lightning and power supply surges.
13. **Overloading.** Do not overload AC wall outlets, extension cords, or integral convenience outlets as this can result in a fire or electric shock hazard.
14. **Object and Liquid Entry.** Never push objects of any kind into this product through openings as they may touch dangerous voltage points or short out parts that could result in a fire or electric shock. Never spill liquid of any kind into the product.
15. **Accessories.** Do not place this product on an unstable cart, stand, tripod, bracket, or table. The product may fall, causing serious damage to a child or adult, and serious damage to the product. Any mounting of the product needs to follow manufacturer's installation recommendations.
16. **A Product and Cart Combination** should be moved with care. Quick stops, excessive force, and uneven surfaces may cause the product and the cart combination to overturn.
17. **Servicing.** Refer all servicing of the product to qualified service personnel.
18. **Damage Requiring Service.** Unplug this product from the AC wall outlet and refer servicing to qualified service personnel under the following conditions:
  - When the AC plug is damaged.
  - If liquid has been spilled or objects have fallen into the equipment.
  - If the product has been exposed to rain or moisture.
  - If the product does not operate normally (following operating instructions).
  - If the product has been dropped or damaged in any way.
  - When the product exhibits a distinct change in performance. This indicates a need for service.
19. **Replacement Parts.** When replacement parts are required, be sure the service technician has used replacement parts specified by the manufacturer or that have the same characteristics as the original parts. Unauthorized substitutions may result in fire, electric shock, or other hazards.
20. **Safety Check.** Upon completion of any repairs to this product, ask the service technician to perform safety checks to determine that the product is in safe operating condition.
21. **Cleaning.** Do not use liquid cleaners or aerosol cleaners. Use only a damp cloth for cleaning.

# HAZARD / WARNING LABELS

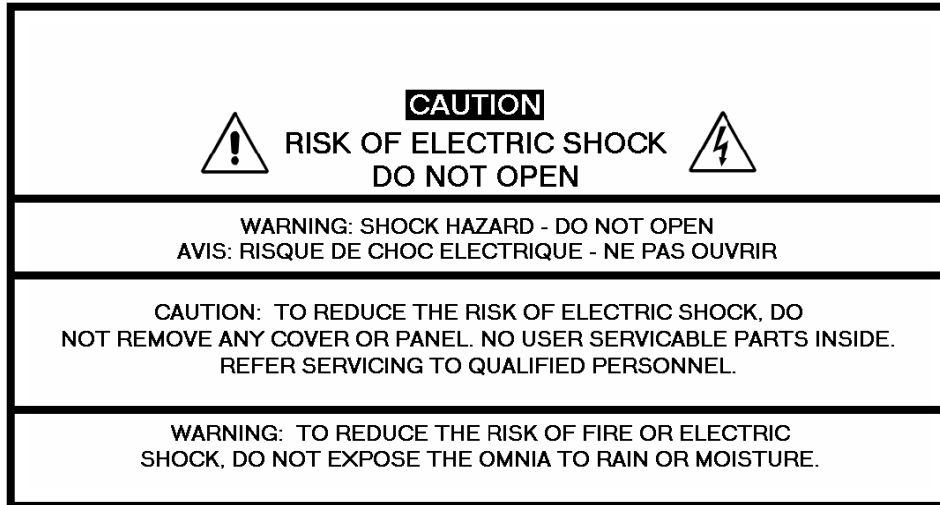

**The Exclamation Point** symbol, within an equilateral triangle, alerts the user to the presence of important operating and maintenance (servicing) instructions in product literature and instruction manuals.

**The Lightning Flash With Arrowhead** symbol, within an equilateral triangle, alerts the user to the presence of uninsulated dangerous voltage within the product's enclosure that may be of sufficient magnitude to constitute a risk of electric shock.



**WARNING** -- This equipment generates, uses, and can radiate radio frequency energy. If not installed and used in accordance with the instructions in this manual it may cause interference to radio communications. It has been tested and found to comply with the limits for a Class A computing device (pursuant to subpart J of Part 15 FCC Rules), designed to provide reasonable protection against such interference when operated in a commercial environment. Operation of this equipment in a residential area is likely to cause interference, at which case, the user, at his own expense, will be required to take whatever measures may be required to correct the interference.

**CANADA WARNING** – This digital apparatus does not exceed the Class A limits for radio noise emissions set out in the Radio Interference Regulations of the Canadian Department of Communications. Le présent appareil numérique n'émet pas de bruits radioélectriques dépassant les limites applicables aux brouillages radioélectrique édicté par le ministère des Communications de Canada.

**CE CONFORMANCE** – This device complies with the requirements of the EEC Council Directives: 93/68/EEC (CE Marking); 73/23/EEC (Safety – low voltage directive); 89/336/EEC (electromagnetic compatibility). Conformity is declared to those standards: EN50081-1, EN50082-1.



**LITHIUM BATTERY CAUTION** -- Danger of explosion if the internal battery is replaced incorrectly. Replace only with same or equivalent type recommended by the manufacturer. Dispose of used batteries according to the manufacturer's instructions.



**USE OF SHIELDED CABLING** -- To conform to the CE requirements for High Frequency radiation, shielded cables must be used for all audio and data connections. For analog and digital connections, the cable shield **MUST** be connected to the XLR-type connector shell, which is at chassis ground potential!

## Manual Update Notification

Due to the dynamic nature of audio processing products, this manual and all future manuals, will be considered as 'preliminary documentation'.

Audio Processing is an art form that we take very seriously. As part of our dedication to this science, we will continue to update both the product and its documentation based on continued research, field experience and valued customer input.

We strongly encourage our customers to visit our Omnia website for product enhancement announcements, software updates, manual updates, and customer care bulletins.

The following URL listing has been included for your update convenience:

Manual Updates	<a href="http://www.omniaaudio.com/support/manuals/manuals.htm">http://www.omniaaudio.com/support/manuals/manuals.htm</a>
Installation Tips	<a href="http://www.omniaaudio.com/support/oinstall.htm">http://www.omniaaudio.com/support/oinstall.htm</a>
Tech Bulletins and Papers	<a href="http://www.omniaaudio.com/techinfo/default.htm">http://www.omniaaudio.com/techinfo/default.htm</a>
Tech Support – Software Upgrades	<a href="http://www.omniaaudio.com/support/default.htm">http://www.omniaaudio.com/support/default.htm</a>
Warranty	<a href="http://www.omniaaudio.com/support/warranty.htm">http://www.omniaaudio.com/support/warranty.htm</a>

Thank you for selecting the incredible Omnia-5EX Audio Processor. Your continued patronage and support are appreciated.

Sincerely,

Team Omnia

# Omnia-5EX Performance Specifications

As of November, 2003 – Version 5.0.0 Software

Note: All measurements made with the supplied “FACT TEST2” preset, which is available in the Preset Submenu.

## System

**Signal to Noise:** The measured noise floor will depend upon the settings of the Input and Output Gain controls. The Omnia 5's noise floor is primarily governed by the dynamic range of the 24-bit Crystal Semiconductor CS5360 A/D Converter, which has a specified Dynamic Range of 105 dB. The dynamic range of the Omnia 5 digital signal processing chain is 144 dB. Typical SNR using the “FactTest2” preset is greater than –80dB referenced to 100% modulation.

**Distortion:** No greater than 0.01% THD 20 Hz -- 20 kHz bandwidth.

## Conventional FM Specifications (FM Analog)

**Frequency Response:** Complies with the standard 50 or 75 microsecond pre-emphasis curve within  $\pm 0.50$  dB, 30 Hz to 15 kHz. The analog left/right outputs and AES/EBU Digital outputs can be configured for flat or pre-emphasized output.

**Signal-to-Noise Ratio:** > -80 dB de-emphasized, 20 Hz — 15 kHz bandwidth, referenced to 100% modulation).

**System Distortion:** Less than 0.01% THD, 20 Hz – 7.5 kHz. Second harmonic distortion above 7.5 kHz is not audible in the FM system

**Stereo Separation:** Greater than 65 dB, 20 Hz — 15 kHz; 70 dB typical.

**Crosstalk:** > -70 dB, 20 Hz -- 15 kHz.

**Composite Outputs:** Configuration: Two electrically independent outputs. Software based level adjustment.  
Source Impedance: 10 ohms or 75 ohms, jumper-selectable. Single-ended and floating over chassis ground.  
Load Impedance: 50 ohms or greater load is suggested.  
Output Level Ranges:  
Low Range: 0.66 to 5.02 V P-P, High Range: 1.45 to 11.02 V P-P, software selectable.  
Pilot Level: Adjustable from 6.0% to 12.0% in 0.1% steps.  
Pilot Stability: 19 kHz,  $\pm 0.5$  Hz.  
D/A Conversion: Burr Brown PCM1704, 24-bit sign-magnitude D/A converter.  
Signal-to-Noise Ratio: -85 dB typical, 75  $\mu$ S de-emphasized, 15 kHz bandwidth, referenced to 100% modulation).  
Distortion: < 0.02% THD 20 Hz – 15 kHz bandwidth, 75  $\mu$ S de-emphasized, referenced to 100% modulation.

*Omnia-5EX Use and Operation Manual – V: 1.1*

Stereo Separation: > 65 dB, 30 Hz – 15 kHz.  
Linear Crosstalk: > -80 dB, main to sub or sub to main channel (referenced to 100% modulation).  
Non-linear Crosstalk: > -80 dB, main to sub or sub to main channel (referenced to 100% modulation).  
38 kHz Suppression: > 70 dB (referenced to 100% modulation).  
76 kHz Suppression: > 80 dB (referenced to 100% modulation).  
Pilot Protection: > -65 dB relative to 9% pilot injection,  $\pm$  1 kHz.  
57 kHz (RDS/RBDS) Protection: better than -50 dB.

Connectors: Two EMI suppressed female BNC, floating over chassis ground.  
Maximum Load Capacitance: 5nF (at 10 ohms source impedance).  
Maximum cable length: 100 feet/30 meters RG-58A/U.

### **HD Radio Specifications (DAB)**

**Frequency Response:** Within  $\pm$  0.50 dB, 30 Hz to 20 kHz.

**Distortion:** No greater than 0.01% THD 20 Hz – 20 kHz bandwidth.

**Signal-to-Noise Ratio:** > -100 dB, 20 Hz – 20 kHz bandwidth, referenced to 0dBfs

**Stereo Separation:** Greater than 95 dB, 20 Hz – 20 kHz; 85 dB typical.

**Analog Audio Input:** Configuration: Left/Right Discrete Stereo. Electronically balanced, floating and symmetrical.  
Input impedance: 10k ohms resistive, electronically balanced.  
Maximum Input Level: +24 dBu.  
Nominal Input Level: A 13dBu input signal nets a -12dBFS input meter reading when the Input Gain Control is set to 0.0 dB. A 1dBu input signal nets a -12dBFS input meter reading when the Input Gain Control is set to +12 dB.  
(Note: When the Input Gain and Master Drive controls are set to 0.0 dB, a +13dBu input signal results in an input level of -12dBFS, and a Wideband AGC gain reduction of -15dB.

**A/D Conversion:** Crystal Semiconductor CS5360, 24 bit 128x over-sampled delta sigma converter with linear-phase anti-aliasing filter. Pre-ADC anti-alias filter, with high-pass filter at <10 Hz.

**Connectors:** Two EMI-suppressed XLR female. Pin 1 chassis ground, and Pin 2 is “hot”.

**Analog Audio Output:** Configuration: Left/Right Discrete Stereo. Electronically balanced,  
Source Impedance: 20 ohms, electronically balanced and floating.  
Load Impedance: 600 ohms or greater, balanced or unbalanced.  
Output Level (100% peak modulation): Adjustable from -6 dBu to +24 dBu peak, into 600 ohms or greater load, software-adjustable.

**D/A Conversion:** Crystal Semiconductor CS4390 24 bit, 128x over-sampled.

**Connectors:** Two, EMI-suppressed XLR-male. Pin 1 chassis ground, Pin 2 “Hot”.



- Digital Audio Input:** Configuration: Stereo per AES/EBU standard, CS8420 Digital Audio Transceiver with 24 bit resolution, software selection of stereo, mono from left, mono from right or mono from sum. Automatically accepts and locks to input sample rates between 8 and 108 kHz.
- Connector:** XLR-female, EMI-suppressed. Pin 1 chassis ground, pins 2 and 3 transformer isolated, balanced, and floating – AES3 standard 110 ohm impedance.
- Digital Audio Output #1:** Stereo per AES3 standard. Output can be configured in software for flat or pre-emphasized response at 50 or 75 microseconds.  
Digital Sample Rates: Output sample rates software selectable for 32kHz, 44.1kHz, 48kHz, and 96 kHz.
- Connector:** XLR-male, EMI-suppressed. Pin 1 chassis ground, pins 2 and 3 transformer isolated, balanced, and floating. Standard AES3 specified 110-ohm source impedance.  
Digital Output Level: -22.0 to 0.0 dBFS software adjustable.
- Digital Audio Output #2:** Stereo per AES3 standard. Output can be configured in software for flat or pre-emphasized response at 50 or 75 microseconds.  
Digital Sample Rates: Output sample rates hardware jumper selectable for 32kHz, 44.1kHz, 48kHz, or 96 kHz, or its rate slaved to AES #1.
- Connector:** XLR-male, EMI-suppressed. Pin 1 chassis ground, pins 2 and 3 transformer isolated, balanced, and floating. Standard AES3 specified 110-ohm source impedance.  
Digital Output Level: -22.0 to 0.0 dBFS software adjustable.
- Digital Sync Input:** External Sync: Output sample rate can be synchronized to the signal present on the AES/EBU input, or to an AES3 signal applied to the Ext. Sync input connector. (Does not accept Word Clock inputs)  
External Sync Range: Accepts sample rates from 32kHz to 96 kHz.  
Used for synchronization of the Digital Output signal to an external reference. Automatically accepts sample rates between 32 and 96 kHz.  
Connector: XLR-female, EMI-suppressed. Pin 1 chassis ground, Pin 2-3 transformer isolated, balanced, and floating. Standard AES3 specified balanced 110-ohm input impedance.
- Note: If AES Output #2 is slaved to AES Output #1 (hardware jumper) and External Sync is selected for AES #1, then AES Output #2 becomes slaved to the sample rate of the Sync input for AES Output #1.
- Remote Control Methods:** Configuration: Modem, Direct Serial, or 10/100BaseTX Ethernet.  
Modem: Optional PCMCIA modem with pop-out X-jack connector or any Hayes command set compatible external modem.  
Direct Serial: Standard RS-232, no hardware handshaking employed.  
Baud rates of 9,600, 19,200, and 57,600 supported.  
TCP/IP Ethernet: Emulates a Telnet session on Port 23.  
Connectors: RS-232 port, EMI-suppressed DB-25 female connector.  
Industry standard EMI suppressed RJ-45 connector for Ethernet.

- Remote Interface:** Configuration: Eight (8) inputs, RS-232 level compatible.  
Software sensing of both 'go-high' and 'go-low' transitions.  
Inputs are protected to +/- 15 VDC.  
Connector: EMI suppressed DE-9 male.  
Control: User-programmable using built-in Trigger Script feature in Omnia 5 Remote Control software. Virtually any parameter of the Omnia 5 may be programmed to change through this interface feature.
- Power Requirements:** Voltage: 100-250 VAC, 50/60/440 Hz., < 75VA  
Connector: EMI suppressed IEC male. Detachable 3-wire power cords supplied for US and European use.
- Internal Power Supply:** Overvoltage and short circuit protected. Meets EN55022, EN55011 Level B Conducted Emissions. EN61000-4-2, -3, -4, -5, -6 level 3 immunity compliant. Full international safety approval. CE marked.
- Environmental:** Operating Temperature: 32 to 122 degrees F / 0 degrees to 50 degrees C for all operating voltage ranges.  
Humidity: 0-95% RH, non-condensing.
- Dimensions:** 19" wide x 5.25" high x 16" deep (48.26cm wide x 13.335 cm high x 40.64 cm deep) including connectors. Unit requires three EIA rack spaces for proper mounting.
- Shipping Weight:** 35 lbs. / 15.876 kg

Telos/Omnia Research and Development is constantly working to improve the quality of our products. Actual specifications are subject to change or improvement without notice.

## Warranty

This Warranty covers “the Products,” which are defined as the various audio equipment, parts, software and accessories manufactured, sold and/or distributed by TLS Corp., d/b/a Omnia (hereinafter “Omnia”).

With the exception of software-only items, the Products are warranted to be free from defects in material and workmanship for a period of two years from the date of receipt by the end-user. Software-only items are warranted to be free from defects in material and workmanship for a period of 90 days from the date of receipt by the end-user.

This warranty is void if the Products are subject to Acts of God, including (without limitation) lightning; improper installation or misuse, including (without limitation) the failure to use telephone and power line surge protection devices; accident; neglect or damage.

EXCEPT FOR THE ABOVE-STATED WARRANTY, OMNIA MAKES NO WARRANTIES, EXPRESS OR IMPLIED (INCLUDING IMPLIED WARRANTIES OF MERCHANTABILITY AND FITNESS FOR A PARTICULAR PURPOSE).

In no event will Omnia, its employees, agents or authorized dealers be liable for incidental or consequential damages, or for loss, damage, or expense directly or indirectly arising from the use of any of the Products or the inability to use any of the Products either separately or in combination with other equipment or materials, or from any other cause.

In order to invoke this Warranty, notice of a warranty claim must be received by Omnia within the above-stated warranty period and warranty coverage must be authorized by Omnia. If Omnia authorizes the performance of warranty service, the defective Product must be delivered, shipping prepaid, to: Omnia, 2101 Superior Avenue, Cleveland, Ohio 44114.

Omnia, at its option will either repair or replace the Products and such action shall be the full extent of Omnia’s obligation under this Warranty. After the Products are repaired or replaced Omnia will return them to the party that sent the Products, and Omnia will pay for the cost of shipping.

Omnia’s authorized dealers are not authorized to assume for Omnia any additional obligations or liabilities in connection with the dealers’ sale of the Products.

Omnia products are to be used with registered protective interface devices which satisfy regulatory requirements in their country of use.

## TABLE OF CONTENTS

Greetings	2	Schedule	33
Safety Instructions	3	System	33
Hazard / Warning Labels	4		
Notices	6	<b>Menu Selections</b>	<b>34</b>
Specifications	7	Preset	34
Warranty	11	Preset List	34
QuickStart Setup Guide	15	Choose (preset)	34
		Modify (preset)	35
		Save Current (preset)	35
		Save Current As	35
		Compare	35
		Protect	35
		Passcode	36
<b>1 – INSTALLATION</b>		Process	37
<b>Omnia-5EX Pre-installation Tasks</b>	<b>16</b>	Input	37
PC Card and Modem Installation	16	Input Gain Master / Right Trim	37
AC Environment Considerations	17	Master Drive	38
Installation and Connections	18	Input Source	38
Rack Mounting	18	Input Mode	38
AC Connection	18	Input Failsafe	38
Audio Inputs	19	High Pass Filter	39
Audio Outputs	19	Phase Rotator	39
Composite Outputs	19	Pre-emphasis (FM Mode Only)	39
19 KHz Sync Output	20	Output	40
SCA Input	20	Peak Output Level	40
Ethernet Connection	20	Set Levels	40
RS-232 Connection	20	AES-1 Output Sample Rate	40
Interface Connection	21	De-Emphasis (FM Mode Only)	40
Powering Up	22	Outputs	41
		Multiplex Power Limiting	41
		(FM Mode Only)	41
<b>2 – THE OMNIA-5 USER INTERFACE</b>		Encode (FM Mode Only)	42
User Interface Introduction	23	Composite Output 1 & 2	42
Using the Jog Wheel	24	SCA Level	42
		Pilot Injection	42
		Pilot Phase	42
		Separation	43
<b>Level Meters and Processing Bargraphs</b>	<b>25</b>	Schedule	43
Audio I/O Level Display	25	Schedule List	43
Processing Display	25	New	43
		Modify and Remove	43
<b>Main Menu Display</b>	<b>26</b>	Load From Card	43
Home Icon	26	Save To Card	44
“X” Close Window Icon	27	Current State	44
Remote Control via Network Indicator	28		
Headphone Level Control	28	<b>Menu Selections, continued</b>	
		System	44
<b>User Interface Tutorial</b>	<b>29</b>		
<b>Menu Overview</b>	<b>31</b>		
Menu Items	31		
Preset	31		
Process	31		
Input & Output Submenus	32		
Encode	32		
<b>Menu Overview, continued</b>			

Port Baud	44	Studio Microphone Processing	54
Security Lev(el)	44	Processor Latency / Time Delay	55
Backlight	45	Operating Levels	55
Set Time	45		
Set Date	45	<b>Omnia-5EX Connections</b>	56
About	45	Output Connection Options (FM Mode)	56
Change Password	45	Interfacing with a Digital STL/ Exciter (FM Mode)	56
Lock Unit	46	Pre-emphasis – where to insert? (FM Mode)	57
Resetting Passwords to Factory Defaults	46	Output Connection Options (HD Mode)	58
Load Defaults	46	AES-2 Output Sample Rate Settings	59
Load From Card	46		
Save To Card	46	<b>5-FINE TUNING YOUR SOUND</b>	
Reboot	46	About Loudness and Listener Fatigue	60
Reset Passwords for Levels 1 & 2	46	Clarifying your Processing Objectives Adjustment Procedure	60 61
Security Config	47	Meter Displays	62
NTP	47	AGC Metering	62
		Limiter Metering	62
Network	48	Interpreting the Meters	63
Mac Address	48	About Factory Presets	64
IP Address	48	Loading a Preset	65
Gateway	48	Parameter Editing	66
Subnet Mask	48	Adjusting the Wideband AGC	67
Save Changes	48	Adjusting AGC Crossovers	68
Reboot Display	48	Adjusting the Two-Band AGC's	69
Test Broadcast	48	Adjusting the AGC Mixer	70
		Adjusting The Enhancers	70
		Adjusting the Limiters Crossover	72
		Adjusting the Multiband Limiters	73
		Adjusting the Final Mixer (Lim Mix)	74
		Adjusting the Clippers (FM Mode)	75
		Adjusting the Look Ahead Limiter (HD Mode)	76
		Saving, Naming, Deleting and Protecting Presets	78
		Saving Presets	78
		Renaming and Deleting Presets	79
		Protecting Presets	79
		Passcode	80
		<b>Getting the Sound You Want</b>	<b>81</b>
		A Word About Loudness	81
		Quality versus Loudness	81
		Increasing Loudness	82
		<b>Getting the Sound You Want, continued</b>	
		Adding More “Detail” to the sound	83
		Making Sound Equalization Changes	83
		Thunder Bass	84
<b>3-THE OMNIA-5EX AND AUDIO PROCESSING</b>			
<b>Process Block Diagram</b>	<b>49</b>		
Wideband AGC	50		
Phase Linear Crossovers	50		
Two Band AGC	50		
Enhancer Section	50		
Deep Bass EQ	50		
Phat Bass EQ	51		
Warmth EQ	51		
Stereo Expander	51		
Multiband Dynamic Peak Limiter	51		
Distortion Canceled Clipper	51		
Look Ahead Limiter (HD Mode Only)	51		
Stereo Generator / Encoder	52		
Composite Clipper	52		
Pilot Protection Filter	52		
<b>4- PROCESSOR INTERFACING</b>			
Processor Location	53		
Analog STL Use	53		
Digital STL Use	54		
<b>Processor Interfacing, continued</b>			
Monitoring Location	54		
Source Material Quality	54		

## 6 – REMOTE CONTROL SOFTWARE

Software Installation	85
Finding the software version number	86
Setup and Configuration	86
Edit Connection dialog box	87
Using the optional modem card	88
Using your own modem	88
Using a Direct Serial Connection	89
Connecting via Modem	89
Custom modem initialization strings	90
Using an Ethernet Based Connection	92
Upgrade Software Feature	92
Establishing a Remote Session	93
Terminal Programs/Direct Connection	94
<b>Trigger Script Editor</b>	95
Dry Contact Closures	95
Applying Control Voltages	95
What Can Scripts Control?	95
Use of Trigger Scripts	96
Paras and Sysparas	96
Using the Editor	96
Script Command Definitions	97
Dayparts	97
Presets	97
Non-system Parameters (paras)	98
System Parameters (sysparas)	99
Setting New syspara Values	100
<b>Trigger Script Editor, continued</b>	100
Creating a Trigger Script	100

Example: Switch to Mono	100
Example: Switch to Stereo	101
Interface Connector	102
“One Way” Scripts	102
Scripting via Daypart Scheduler	103

## 7 – TROUBLESHOOTING

Rear panel serial port setup	104
Normal boot up message	105
Audio Failure Alarm	106
Audio Restoration Alarm	106
Diagnostic & Error Messages	107
Safety Note!	109
Narrowing down problems	109
Obtaining Service	110

### Appendix A

CE Declaration of Conformity	112
------------------------------	-----

### Appendix B

Audio Processing FAQ	114
Factory Preset Descriptions	117

### Appendix C

Omnia-5EX Parameter Worksheet	120
-------------------------------	-----

### Appendix D

Software Upgrade Procedures	121
-----------------------------	-----

### Appendix E

GNU General Public License	122
----------------------------	-----

# Omnia-5EX Quick-Start Setup Guide

We know that you're probably in a hurry to get on the air with your new Omnia-5EX. If you have technical expertise and previous knowledge of audio processor fundamentals, using the following Eight-Point Quick-Start Checklist will get you up and running as quickly as possible. Please refer to the remainder of the Operating Guide for additional information. Refer to the following drawing for the location of the various connectors associated with the installation:

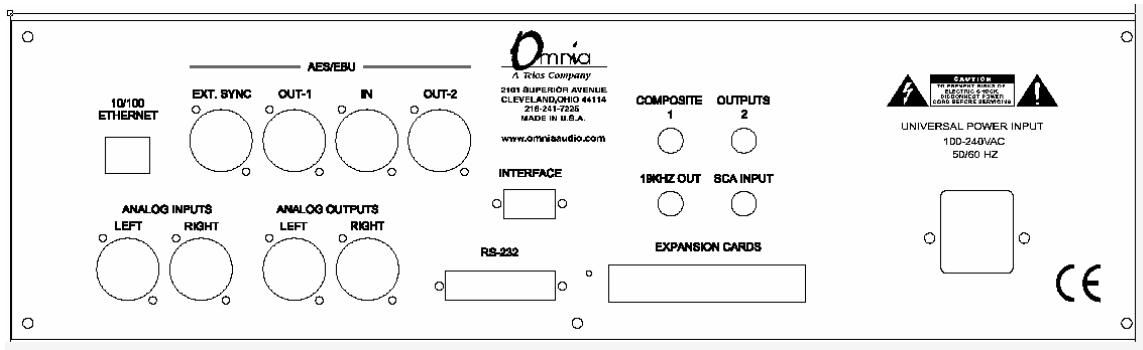

1. Install the Omnia-5EX in the equipment rack using at least two rack screws. If only two screws are used, they **MUST** be in the bottom holes of the rack ears!
2. Connect AC power to the unit, and turn on power using the rear-panel power switch.
3. Connect the audio inputs that are appropriate for your installation.
4. Navigate to the Input Menu and select the Analog or AES/EBU input. If your audio source is providing an audio feed you should see meter activity on the Input, Output, and Processing meters.
5. While in the Input menu and observing the Input meters, adjust the left and right input level controls until the input meters are peaking between  $-12$  and  $-6$  dBFS.
6. Connect the audio outputs that are appropriate for your installation.
7. If you are using the Analog or Digital audio outputs, navigate to the Output Menu and adjust the output levels for the equipment that follows the Omnia.
8. If you are using the Composite Outputs, navigate to the Encode Menu and adjust the Composite Outputs to match the device following the Omnia-5EX.

You're now ready to go on the air!

Note that the Omnia-5EX is shipped with the *RocknRoll* preset as the default. While leaning toward the competitive side, it provides a rich and balanced sound - a good starting point for nearly every format. Remember that our preset names do not necessarily mean that the preset is useful for *only* the formats to which the name refers. Feel free to experiment! Short descriptions of the 22 Factory Presets can be found in Appendix B on Page 117.

## Chapter-1: Pre-Installation

Even though we believe the Omnia-5EX is the easiest processor to install in its class, please take a few minutes to

*Omnia-5EX Use and Operation Manual – V: 1.1*

read through this chapter before proceeding with the installation. This section offers common procedures for installing your new Omnia-5EX processor. Note that there are additional installation and operation tips presented in Chapter 4 that may pertain to your specific installation.

## About This Manual

Some features apply only to HDFM channel features (such as the Look Ahead Limiter). These will be noted in parentheses after the section heading: **(HD Mode Only)**. Similarly, sections that specifically cover conventional FM channel features will also be noted in parentheses after the section heading: **(FM Mode Only)**

## Omnia-5EX Components

By now, you've unpacked the shipping carton to gain access to this manual. Now is the time to inspect the Omnia-5EX unit and its shipping carton for any signs of shipping damage, which must be reported to your carrier for any claims. The Omnia-5EX shipping box includes the following components:

Omnia-5EX processor (containing the DSP hardware)

Omnia-5EX PCMCIA Type Memory card (holding the DSP software)

Omnia-5EX Operating Manual (this document)

Warranty Registration Card (Please complete the form and return/FAX it to Telos/Omnia)

Two IEC Power Cords, one for use in the US, and one for use in Europe

## PC Card & Optional Modem Installation

Before installing your Omnia-5EX, or even plugging in the power cord, make sure the Omnia-5EX PC Memory Card and Optional Modem Card (if purchased) are installed into the correct card slots on the back panel and are fully seated. Installation or removal must be done with the power *off* unless directed otherwise.

The PC Memory Card is inserted into the *top* card slot with the Omnia label facing up and the version number sticker facing down. The Optional Modem Card is inserted into the *bottom* card slot below the Omnia PC Card. Both the PC Card and the Modem Card are keyed to prevent improper insertion. Gently press the cards into the slots until the black release button, to the right of the card, pops out about 1/2" [12.70 mm]. This indicates the card is properly seated in the PCMCIA slot.

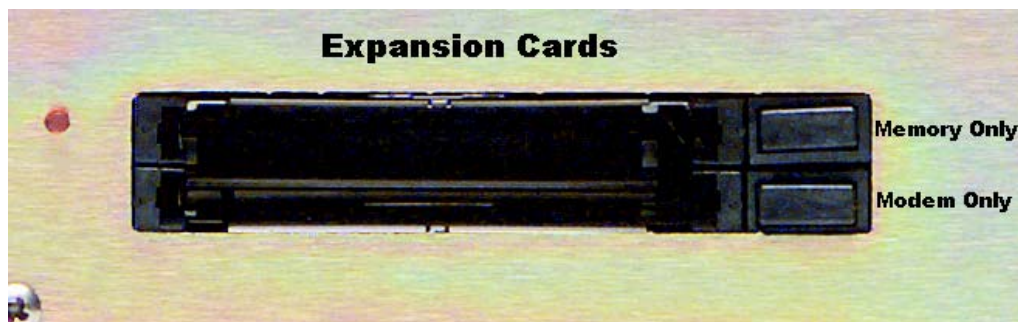

The Omnia-5EX also contains a third PC Memory Card slot that is used to load software for the Front Panel. The slot is located under the top cover on the right-hand side of the Front Panel circuit board and is normally unoccupied. Please do not insert or remove any PCMCIA cards from this slot without the direct assistance of Telos /



Omnia customer support. Make sure the AC power is *off* and disconnected from the unit before removing the top cover and removing or replacing a card.

**Important Note 1:** The PC Cards used in the Omnia-5EX are not *generic* PCMCIA cards that can be bought in any local computer store. They are cards that are specially qualified by Omnia specifically for this product. If you need a backup card, please contact Omnia Customer Support to purchase an additional card. Inserting a card of unknown origin risks damaging the Omnia, the cards, or both, and doing so will void your warranty!

**Important Note 2:** If you wish to operate the Omnia-5EX using a PCMCIA type modem, you must use the available modem card from Omnia. Other modem cards are NOT qualified for use at this time. We cannot provide technical support for any other modem card. External modems are a different case. Typically, any external Hayes compatible modem may be connected to the rear-panel serial port. See Chapter 6 for more details on the Modem and the Remote Control Software.

**Note:** The rear panel PCMCIA Memory Card must remain in the top slot unless you are prompted by the system to remove it. Randomly removing the PC Card without system instruction may cause unpredictable operation and PC Card data damage.

## AC Environment

The Omnia-5EX subsystem is microcomputer-based. Therefore, it requires the same clean AC environment as any modern computer system does. Even though the Omnia-5EX is equipped with quite robust internal AC input transient suppression, we recommend that external transient suppressers/voltage regulation or an Uninterruptible Power Supply (UPS) be employed. This recommendation becomes even more important when installing the processor at a transmitter site, where there can be heavy transients on the power lines. These unwelcome events can be caused by anything from load switching to lightning strikes on a nearby tower. Therefore, we ask that you give your AC power environment and installation practices thorough consideration before plugging in your Omnia-5EX unit.

## Installation & Connections

Throughout this section reference is made to “software parameters.” These are part of the Graphical User Interface, which is covered in detail in Chapter 2.

### Rack Mounting

The Omnia-5EX requires 3RU (5.25” [37 mm]) of rack space. Rack mount the unit using four rack screws. If only two screws are going to be used, they should be in the bottom holes in the Omnia front panel. No other two-screw mounting arrangement will prevent distortion of the front panel casting! Adequate ventilation should be provided, and it is always good engineering practice to allow one blank rack space immediately above and below the Omnia, especially if equipment generating significant heat is located below the unit. Install a 1RU (1.75”) vented or solid panel to fill these spaces.

The processor should be installed into a thoroughly grounded 19” equipment rack. Refer to Chapter 4, “Processor Interfacing”, for additional considerations on where to physically locate your processor.

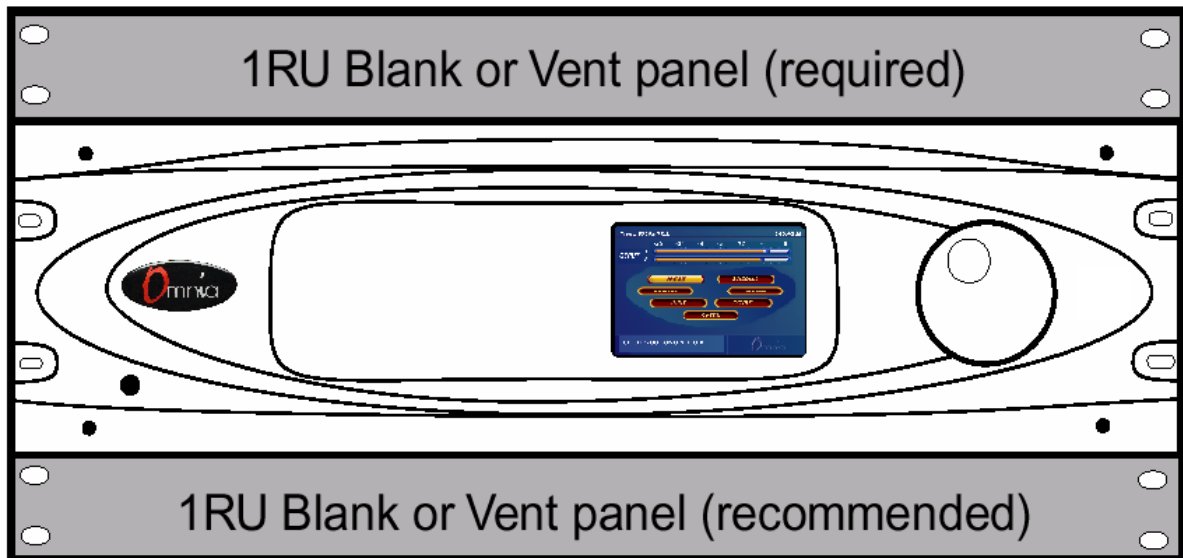

### ***Omnia-5EX Rack Mounting Requirements***

#### AC Connection (IEC)

The Omnia-5EX utilizes a heavily filtered, universal AC power-entry module. Its integral power switch is located just above the IEC power cord receptacle. The Omnia-5EX’s voltage-sensing, switching power supply allows it to operate on AC mains voltages from 100 to 240 VAC, 50/60 Hz. In the USA, plug the provided IEC type AC power cord into the unit and then into a grounded AC outlet. Outside of the USA, you must use the appropriate power cord that complies with local electrical regulations.

Press the “I” side of the rear-panel power switch to turn on the unit. The Omnia-5EX is designed to be continuously powered, however, pressing the “O” side of the switch turns off the unit for servicing.

When power is first applied, it takes approximately ten seconds to load the DSP code from the rear-panel PCMCIA memory card. During system power-up, the front panel LCD screens display several status screens while the

operating software and DSP code is loaded. Once the main Omnia-5EX Main Menu is shown on the right screen, and the Meter Screen is shown on the left display, the unit is ready for use.

## Rear Panel Connections

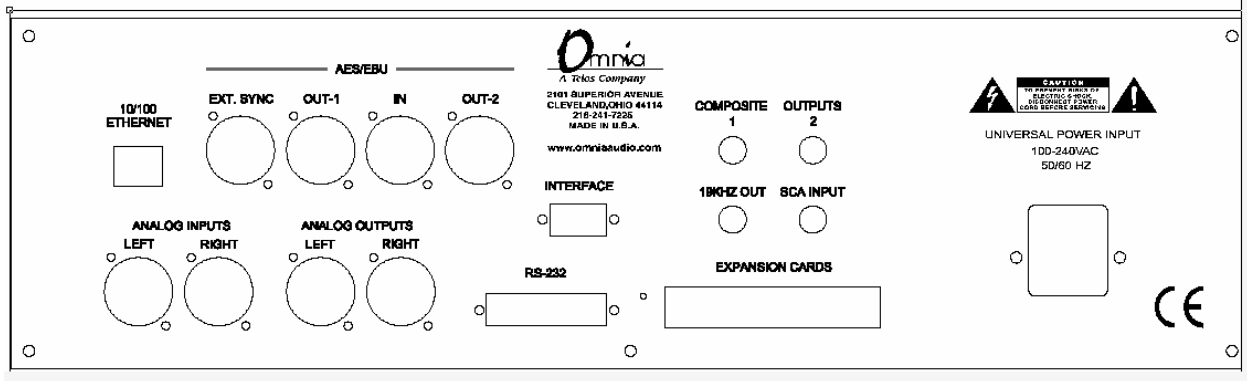

### Audio Inputs—Analog & Digital (Female XLR)

Balanced XLR-type connectors are used as input connectors for both the analog and AES-3 digital audio. Both analog and digital input sources may be connected simultaneously, however, only the input source that has been set in the Input menu is active. Analog/Digital Input source selection is done through the *Input Source* software parameter setting in the Input Menu.

The stereo analog inputs are designed for standard +4dBu balanced signals. Pin 2 is Hot. The digital AES-3 inputs (IN and EXT. SYNC) accept any sampling rate between 32kHz and 96kHz. No user adjustment is necessary on the AES input since a high-quality sample rate converter is built into the unit. Individual channel gain and level setting for both analog and digital is done using the *Input Gain* software parameter settings in the Input Menu.

**A Note About Relative Phase:** If the relative phase of your installation (including the Omnia-5EX) differs from that of your existing system, your announcers may feel that they sound “weird” in their headphones. If this occurs, then the relative phase of the processor is 180 degrees from what your air talent is used to. To remedy this, you can either reverse the polarity of both of the analog inputs or change the *Invert Both* software parameter setting in the Omnia-5EX Input Menu.

### Audio Outputs—Analog & Digital (Male XLR)

Individual Left and Right analog outputs are available on two male XLR jacks. There are two AES outputs. They are user configured for the conventional FM channel and/or the HD Radio/DAB signal. The outputs labeled *OUT-1* and *OUT-2* provide selectable sampling rates. The analog output is derived from a D/A converter driven from whichever digital output is desired, either FM or HD/DAB.

**Note:** Both the analog and digital AES-3 outputs are always active and can be used simultaneously.

### Composite Outputs (BNC) (FM Mode Only)

These two low impedance outputs (Composite 1 and Composite 2) are each capable of driving up to 100 feet of RG-58A/U coax cable. The output levels are individually adjustable between the outputs so the unit can operate as a “composite DA” to drive a variety of equipment. The output levels and other stereo generator settings are set through software parameters in the Encode menu. An internal jumper sets the output impedance to either 10 ohms (the factory setting) or 75 ohms. The default setting is appropriate for the vast majority of exciter connections. However, in the event a higher source impedance is required a jumper can be moved (one for each composite

output) on the motherboard to change the source impedance to 75 ohms. For reference, J10 is for Composite #1, and J13 is for Composite #2.

### 19 kHz Sync Output (BNC) (FM Mode Only)

This TTL-level 19 kHz square wave output can be used as the reference signal for any SCA generator that operates at 57 kHz or other multiple of the 19 kHz pilot frequency. This Sync output is phase and frequency locked to the stereo pilot. When this signal is used to synchronize an external SCA or RDS generator, this locking assures that no difference frequencies exist which may cause intermodulation components between the pilot and the SCA signal.

### SCA Input (BNC) (FM Mode Only)

Any SCA signal above 53 kHz can be added to the composite outputs of the Omnia-5EX by connecting the SCA signal to the SCA INPUT connector. The SCA signal is mixed in the analog domain directly into both composite outputs. A high-pass filter on the SCA input provides SCA to main-channel crosstalk protection. The SCA deviation level is controlled through the *SCA Level* software parameter in the Encode Menu.

### Ethernet Connection

The Remote Control link for your Omnia-5EX can take several forms. Dial-up modem, RS-232 serial, and TCP/IP over 10BaseT and 100BaseT networks can be utilized. Using any of these options requires the Omnia-5EX Remote Control application that can be downloaded from <http://www.omniaaudio.com>, the Omnia website. The setup and operation of the Remote Control software application is covered in detail in Chapter 6.

### RS-232 Connection (DB-25F)

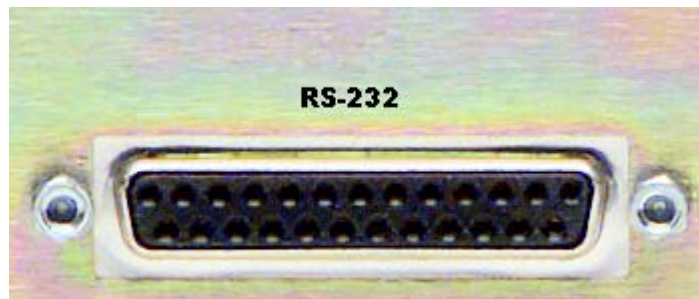

This connector serves two important purposes: It can be used for a local, bi-directional computer connection with Omnia-5EX Remote Control, or it can be used for troubleshooting and error code resolution. In the former case, Omnia-5EX Remote Control software is utilized. In the latter, any terminal emulation program can be used. In either case, you must use a standard, straight-through serial cable (*not* a null modem cable) between the RS-232 connector and the serial port connector on the computer. Typically, a DB25 male to DB-9 or DB-25 female cable will be used, with the DB-25 male end of the cable attached to the Omnia-5EX.

The setup and operation of the Omnia Remote Control application is covered in detail in Chapter 6.

## Interface Connection (DB-9M)

This connector is the interface to the Omnia's internal trigger script function. Eight of the pins are “trigger” inputs and the remaining pin is the ground reference. The trigger inputs can be used to dynamically alter the Omnia-5EX's operation in response to logic signal transitions at the interface connection. There is a unique response to each trigger input, that is, both “go-high” and “go-low” transitions are sensed. With eight inputs, and two sensed states for each one, sixteen unique 'trigger events' may be sensed to control the Omnia-5EX in response to these input logic transitions. Virtually ANY parameter of the Omnia can be controlled using the Trigger Scripts.

The Trigger Script Interface Editor is a standard component of the Omnia-5EX Remote Control application and is covered in detail in Chapter 6.

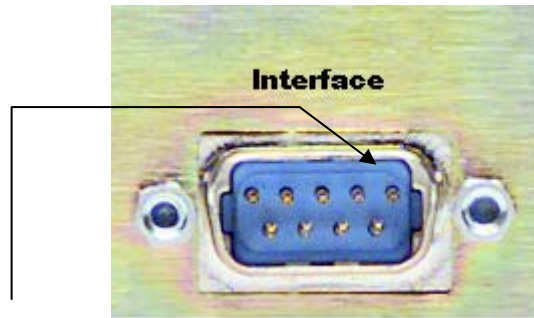

**Pin 1 Rear Panel Interface Connector for Remote Trigger Script Activation**

The *Pinout* of the Omnia-5EX rear-panel DB-9 Interface connector is as follows:

- PIN 1 activates Trigger Script 1
- PIN 2 activates Trigger Script 3
- PIN 3 activates Trigger Script 8
- PIN 4 activates Trigger Script 6
- PIN 5 is connected to ground
- PIN 6 activates Trigger Script 2
- PIN 7 activates Trigger Script 4
- PIN 8 activates Trigger Script 7
- PIN 9 activates Trigger Script 5

## Powering Up

When the Omnia-5EX is first turned on, there is a few seconds of delay as the system starts up. You should notice a revolving *Omnia* logo on the screen, and then the Main Menu screen should appear.

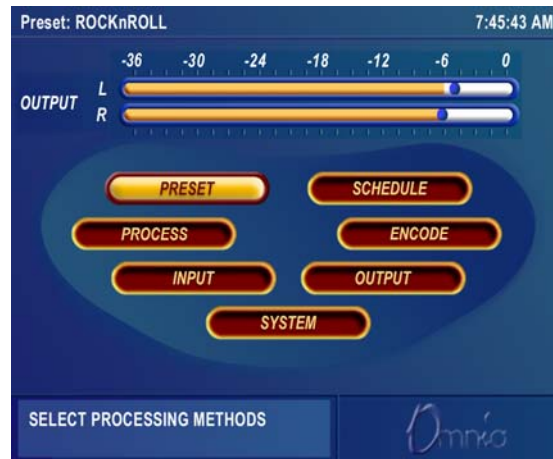

After approximately ten seconds, audio will be present from the analog, composite and headphone outputs. The AES/EBU outputs also become usable at this time. However, full initialization of the ports is not complete for several more seconds and there could be a brief, sub-second interruption while the AES/EBU IC's configurations are being verified by the operating system. After 25 to 30 seconds the Main Menu display will appear on the LCD screen. At this point, the Omnia-5EX is fully operational.

# Chapter-2: The Omnia-5EX User Interface

Now that your Omnia-5EX is rack-mounted, connected to a program audio source, and turned on, you're ready to learn how to operate it! This chapter covers the Graphical User Interface, your window into the Omnia-5EX processor.

A front panel jog-wheel with integral push switch and an Active-Matrix Color LCD makes up the Omnia-5EX Graphical User Interface. Two "Display Modes" are available: One is the "Menu Display", and it shows the menus, submenus and user-adjustable parameter settings. The other is the "Meter Display". It shows bargraph indications for the AGC and Limiter stages, as well as VU and 'digital sample accurate' peak indications of the Input and Output Levels.

**Simply pressing and holding the jog wheel button for two seconds toggles between the two display modes.**

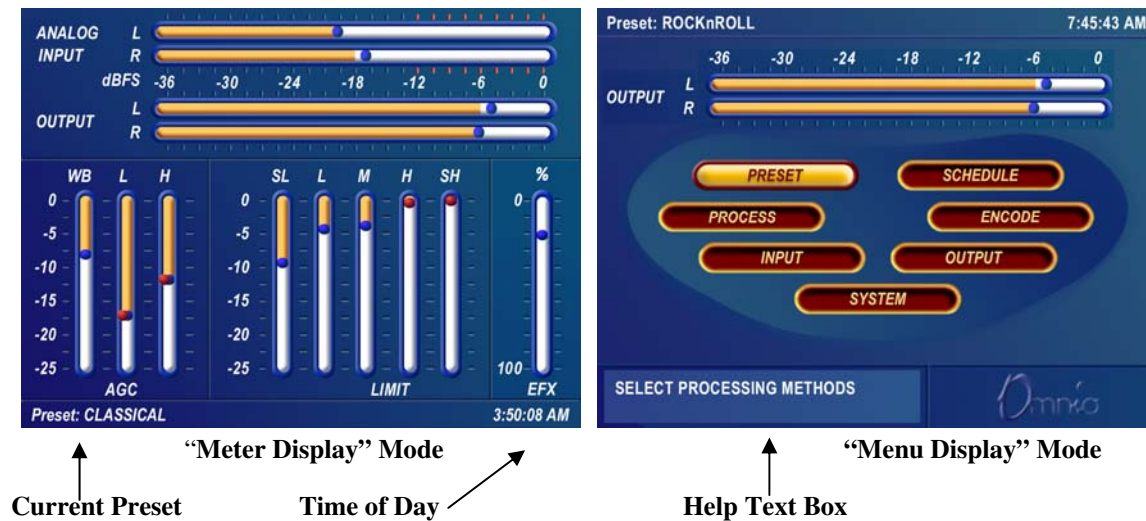

The functions of the Menu Display can be selectively password protected from unauthorized processing or preset changes. The Meter Display dynamically indicates real-time signal processing activity, as well as the Input/Output levels. The backlights for the two displays are automatically turned off after a user set period of jog wheel inactivity, and the factory default timeout is 15 minutes. User options of 5, 15 and 60 minutes turn-off times can be customized under the System submenu.

## Using the Jog Wheel

The main user control for the Omnia-5EX is the large, easy to use jog wheel with its integral push-switch. Using the control is both intuitive, and efficient, making it easy to navigate the menu structure of the Omnia-5EX. Processing changes and system adjustments can be quickly made with ease without having to remember multiple controls, their positions, and what they do in each menu. The behavior of the Omnia-5EX's menu system is consistent across pages and is easy to learn. We believe that you will quickly become comfortable with how it works, and appreciate its simplicity.

See the diagram below to learn how each movement of the jog wheel affects the various menu options.

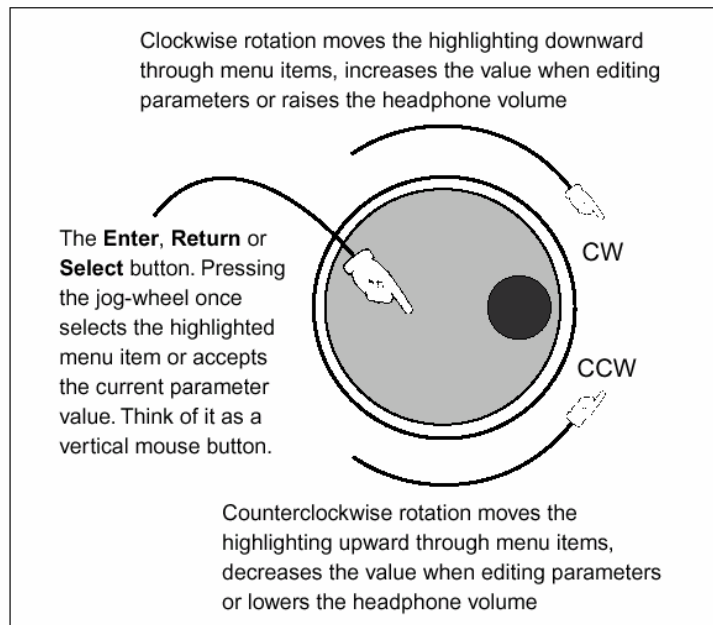

*Jog-Wheel Functions*

Pressing and holding the jog wheel for two seconds will toggle between the Menu and Metering display modes.



## Level Meters & Processing Bargraphs

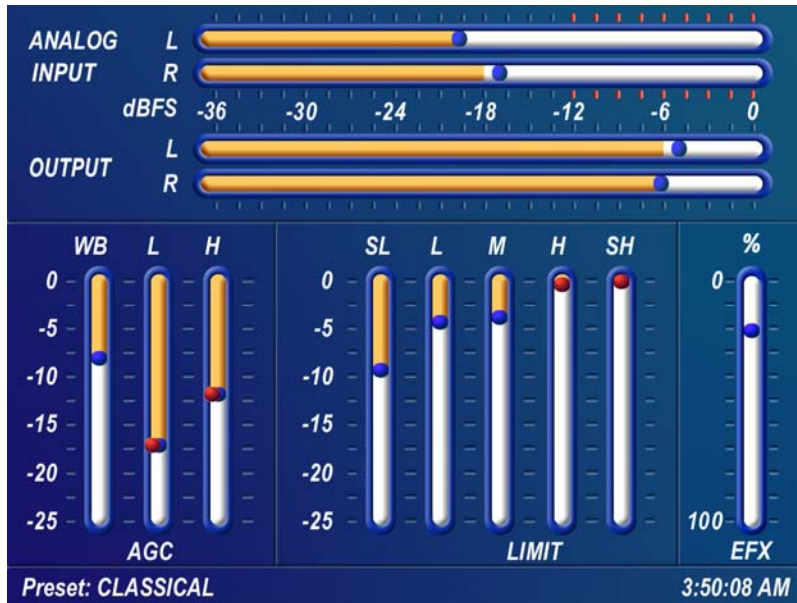

Meter Display Mode screen showing I/O and process bargraphs

In “Meter Display” Mode, the horizontal meters show digital, sample-accurate, **peak** representations of the left and right input and output levels, while the vertical bargraphs show processing activity of the various algorithms. The currently selected Preset Name is displayed in the bottom left corner of the Meter Display, the currently entered IP address in the center and the current time is displayed in the lower right corner.

### Audio I/O Level Display

The horizontal meters show the signal levels below full scale digital, (0 dBFS) which is the absolute maximum level in the digital domain. Both input and output levels are displayed in real time. The “bouncing balls” indicate sample-accurate peak signal levels. In normal operation, the “bouncing balls” in the Input meters should regularly indicate between -12 and -6 dBFS. Since the meters are indicating the true peak level, this will give you about 20 dB of "VU" system headroom given typical (not hyper-compressed) program material. The Output meters indicate the peak levels at the analog and digital XLR outputs but not the composite MPX outputs.

### Processing Display

The nine vertical bargraphs in the lower half of the Meter Display show the processing activity in real time within the Omnia-5EX. The first vertical meter (labeled W) represents the processing activity in the Wideband AGC section. The two vertical “AGC” meters show the processing activity of each of the AGCs in the two-band AGC section. The five vertical “Limit” meters show the processing activity in each of the limiter sections of the multi-band limiter. Each of the meters is capable of indicating up to 25 dB of gain reduction.

The rightmost vertical bar graph (labeled EFX) indicates the processing level of the (optional) Stereo Enhancement effect.

**Note:** The wideband AGC and Two-band AGCs will recover to a resting gain setting which coincides with the RTP (Return To Platform) levels set for each band. Refer to Chapter 5, “Fine Tuning Your Sound”, for more information on interpreting and using the processing bargraph displays.

# Main Menu Display

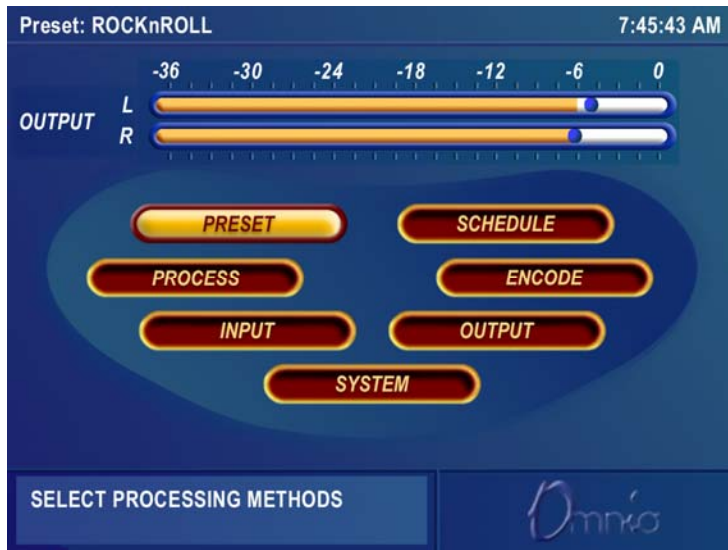

The *Omnia-5EX Main Menu* is displayed on the LCD screen in “Menu Display” Mode, and offers seven menu selections: *Preset, Schedule, Process, Encode, Input, Output and System*. Below the Main Menu in the lower left corner of the display is a multipurpose “Help Text” box.

The Omnia-5EX menu system has been designed to be intuitive and simple to use, with a minimum of layered submenus. Most operating parameters are found on one of the seven main menus. This allows multiple processing changes to be made quickly and with ease.

Remember that to switch between the Main Menu and the Metering screens simply press and hold the jog-wheel button for two seconds.

When the Main Menu is displayed (as shown above), rotating the jog-wheel sequentially highlights each menu item. This is called Highlight Mode. With a menu item highlighted, pressing on the jog-wheel (called “clicking”) brings up that item’s submenu window. Similar action results when submenus are selected under these seven main menus.

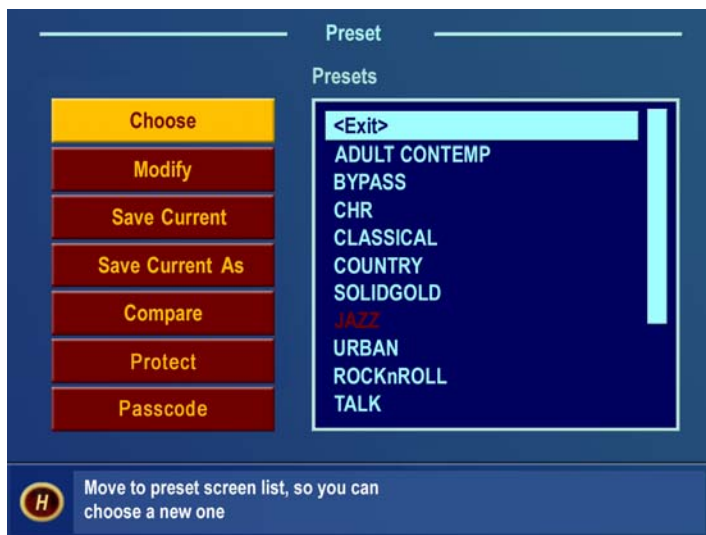

↑ “Home” Icon

Preset Submenu

The *Preset* menu item is shown highlighted in the Main Menu Screen illustration above. In this case, clicking the jog-wheel would open the *Preset Submenu window* (shown at left). To exit a submenu and move back to the main menu, highlight the “H” Home icon in the lower left corner, and click the jog-wheel.

In all submenus with adjustable parameters, rotating the jog-wheel sequentially highlights each control or selection choice, along with the Home icon and the Headphone level control. In the Process submenu, the parameter adjustment windows have an “X” Close Window icon in the upper right corner (as shown in the AGC Mixer window below). Highlighting this icon and clicking closes the window, returning the user to the Process submenu, one level above.



### AGC Mixer Submenu

To change the selection in a multiple-choice parameter, highlight the desired choice with the jog-wheel and click. A filled box serves to indicate that a parameter choice is selected.

To adjust a “rotary” knob control, like those shown in the AGC Mixer Parameter Window, highlight the control and click. The jog-wheel now functions as a rotary control. Rotating it clockwise adjusts the control up; counter-clockwise adjusts the control down. The adjusted value is shown below the control. The original value is retained in a different color until the jog-wheel is clicked to make the new value permanent.

To cancel a control change, return the jog-wheel to the control’s original value. To apply a new level or value and return to Highlight Mode, just click the jog-wheel.

## Remote Control Session via Network Indicator

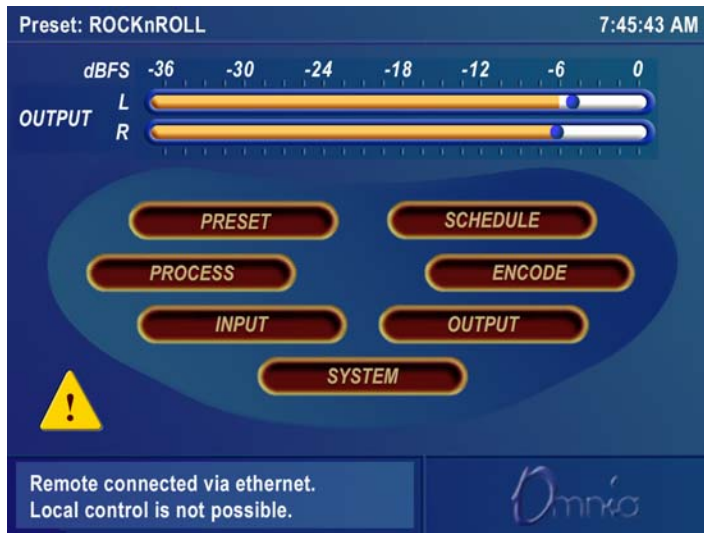

Omnia-5EX Main Menu

An exclamation mark inside a yellow triangle will show up in the lower left corner of the Main Menu screen when a Network remote session is in progress. A remotely connected network session has priority over local control of the front panel, so during a Network remote session the Main Menu will be grayed out. You may disconnect a Network remote session and regain front panel control by clicking the Disconnect Remote button.

The triangle with exclamation mark signifies that a TCP/IP Remote Control session is active.

**Note:** No front panel indication is shown when a serial or modem based remote control session is in progress!

## Headphone Level Control

A standard 1/4" stereo headphone jack located at the lower left corner of the front panel allows the processed signal to be monitored, and a Headphone volume level control is available in each submenu. When the headphone volume control slider is highlighted, clicking changes the jog-wheel into a headphone volume control. Once the headphone volume is adjusted to your liking, clicking the jog-wheel exits the volume adjustment mode, returning the jog-wheel back to Highlight Mode.

**Note:** The headphone amplifiers are fed from the same high quality, 24-bit D to A converter as the analog XLR outputs. Therefore, the overall Headphone volume will also be affected by the setting of the *Peak Output Level* controls in the Output Menu.

# User Interface Tutorial – Input Source Selection and Peak Input Level Setting

The following two exercises are a useful introduction to the user interface. Start from the Main Menu (as displayed when the unit is first turned on).

The first exercise changes a parameter selection (the *Input Source* selection):

1. If the Menu Display is not showing, press and hold the jog-wheel for two seconds to display it.
2. Rotate the jog-wheel to highlight *Input*.
3. Click the jog-wheel (push on the wheel once) to bring up the *Input* window (shown below).

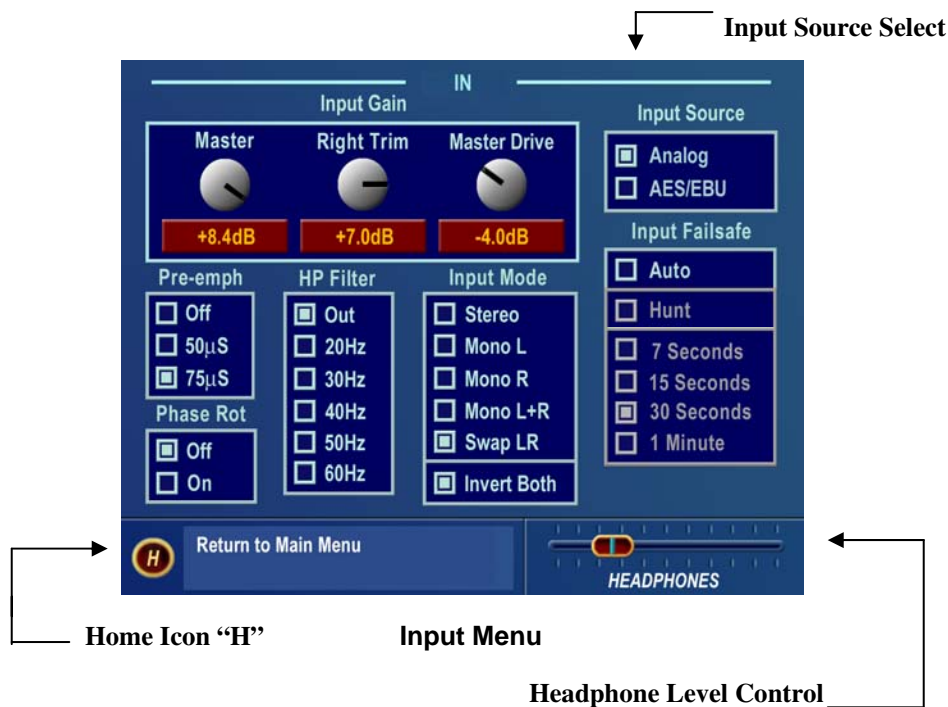

4. Rotate the jog-wheel until one of the *Input Source* choices: *Analog* or *AES/EBU* is highlighted. The filled box next to the selection name identifies the current selection. The factory default selection for Input Source is *Analog*. To change the selection to *AES/EBU*, highlight *AES/EBU* and click. The *AES/EBU* box will now be filled and the digital input is now active. If you are using the analog inputs, highlight *Analog* and click to reselect the Analog inputs.
5. Rotate the jog-wheel until the *Home icon "H"* is highlighted in the lower left corner of the window. Click to return to the Main Menu.

The next exercise adjusts a parameter that uses a value. (*Input Gain*)

This also serves as a tutorial on setting the proper input levels for optimum performance:

For complete information on the controls in the Input Menu, see Pgs. 37-38.

1. The Menu Display should still be showing. If not, press and hold the jog-wheel for two seconds to display it.
2. Highlight *Input* and click to open the Input window.

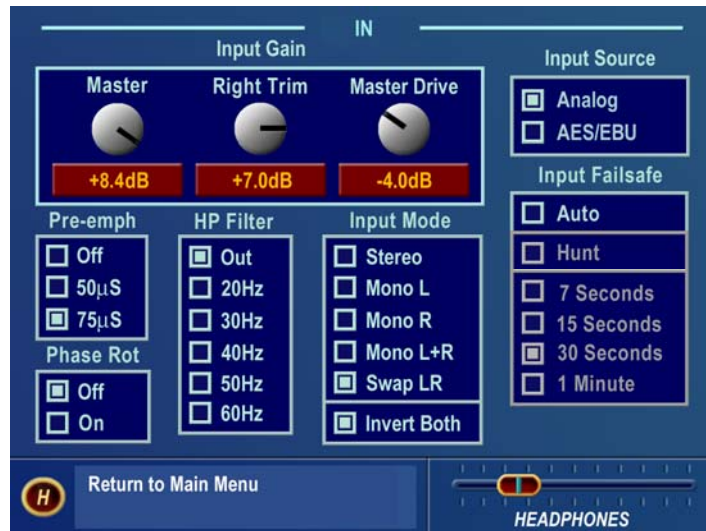

**Input Menu Showing Input Gain Controls**

2. Rotate the jog-wheel to highlight Input Gain *Master* (Not Master Drive), and then click the jog-wheel to select the control.
3. Rotate the jog-wheel CW to increase the input gain. Rotate the jog-wheel CCW to decrease the input gain. This control adjusts both channels together so if your input source is unbalanced, watch the Left channel Input bargraph meter primarily when adjusting. The gain in dB is shown below the “control.” Note that the original setting is always shown in a different color when the control is adjusted. To cancel level changes, move the control back to the original setting and click.

Using normal program audio, a correct gain setting results in **peak** indications (the “bouncing balls”) regularly bouncing up to between -12 and -6 dBFS. Since the meters are indicating the true peak level, this will give you about 20 dB of “VU” system headroom given typical (not hyper-compressed) program material.

5. Once the desired gain is reached, click the jog-wheel to accept and use that value. This returns the jog-wheel to Highlight Mode.
6. Highlight and click Input Gain *Right Trim* and adjust it if the input source is unbalanced. It adjusts the gain of the right channel over a limited range of plus or minus 3 dB.
7. Rotate the jog-wheel until the “*H*”ome icon is highlighted. Click to return to the main menu.

All of the Omnia-5EX’s software parameters are set in a similar fashion using the jog-wheel in Highlight Mode to scroll through menu items and parameters. Clicking a highlighted item selects it; when that item is a control, the jog-wheel adjusts the value or level. Clicking accepts the value or level and returns the jog-wheel to Highlight Mode.



**Note:** Changing any parameter value changes the Omnia-5EX’s audio output characteristics in real time so that all adjustments can be auditioned as they occur.

## Menu Overview

This section presents an overview of the seven submenus (*Preset, Process, Input, Output, Encode, Schedule* and *System*) and their parameters. The *Menu Selections* section, starting on Page 34, gives in-depth descriptions and usage instructions for each submenu item and parameter selection.

### Preset

Omnia-5EX is equipped with numerous factory presets that can be used to instantly configure the processing for common applications. Highlighting *Preset* and clicking the jog wheel will open the Preset submenu. Appearing here is a list of all of the presets stored on the Omnia PC Card. Highlighting a Preset and clicking “Choose” allows that preset to be loaded into the Omnia-5EX, instantly setting the various processing parameters. You may also compare and modify settings between presets, save the current processor settings to an existing or new user preset, rename or delete user presets and password protect user presets using options found on this submenu. See Page 34 for details.

### Process

Highlighting and clicking *Process* opens up the Process submenu, shown below:

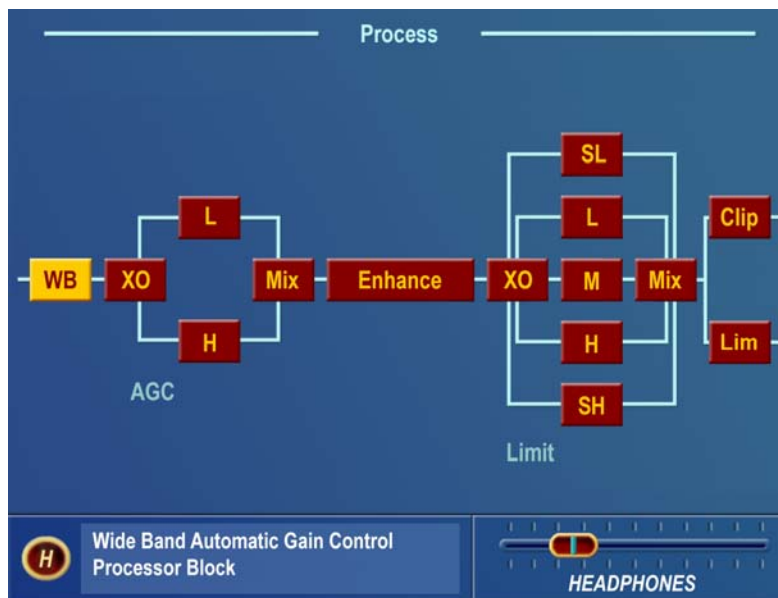

**Process Submenu showing Processing Signal Chain**

This is where the processing power of the Omnia-5EX can be fine-tuned, and your station’s individual sound customized. Each processing subsection in the Omnia-5EX (shown in block diagram format) can be highlighted and clicked to open a parameter window with all of the available controls assigned to that function.

Since you cannot build a preset from scratch, a factory preset must be used as a starting point for creating your “signature sound.” Each signal processor section (from the Wideband AGC to the Clippers) can be individually selected, and its parameters adjusted as required. Once the processing is adjusted, the *Preset* menu “Save As” function is used to save your newly edited factory preset to the rear-panel PCMCIA card as a new user preset. See Chapter 5, “Fine Tuning Your Sound”, for an in-depth discussion of using this submenu to edit presets.

## Input & Output Submenus



**Input Submenu**



**Output Submenu**

These two submenus provide level adjustments for the left and right inputs and the absolute peak operating level of the outputs. Note that the analog and digital Input and Output levels are affected equally by the settings of the Input and Output Gain controls respectively. Choices governing the selection of the input audio source (Analog or AES-3), signal mode (stereo or mono) and whether pre-emphasis and de-emphasis is applied are also found on these submenus. See Pages 37-41 for full details on using the Input and Output menus.

These are generally “set once and forget” selections or parameters, usually adjusted during installation and then left alone. In fact, they are called “System” parameters, and are not saved with a Preset. The “System” can be saved to (and re-loaded from) the PCMCIA card using the Save To Card button in the System Menu. See Page 46 for details.

## Encode (FM Mode Only)



**Encode Submenu**

This submenu contains the adjustments for the DSP based Stereo Generator. The Output Levels for Composite Outputs 1 and 2, the Stereo Pilot Injection Level and Phase, and the SCA Injection Level and Stereo Separation parameters are adjustable here. Like the Input and Output menu choices, these menu items are typically adjusted during installation, and are saved as a System Configuration (see above). See Page 42 for full details.



## Schedule

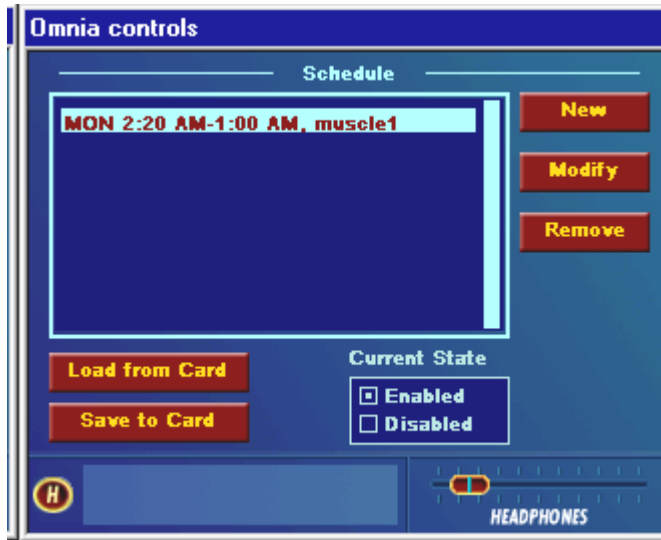

Schedule Submenu

The Omnia-5EX can automatically load presets from the PC Card by date and/or time. The Schedule submenu allows the user to enable or disable the Daypart Scheduler function, as well as to create, modify, save and recall custom preset changing schedules.

In order for presets to change during a schedule, the Preset checkbox in the New or Modify schedule dialog box must be selected. Leave it unselected when you will be using the trigger script function and click on the Scripts button instead to edit the trigger scripts. See Pages 43-44 for full details.

## System

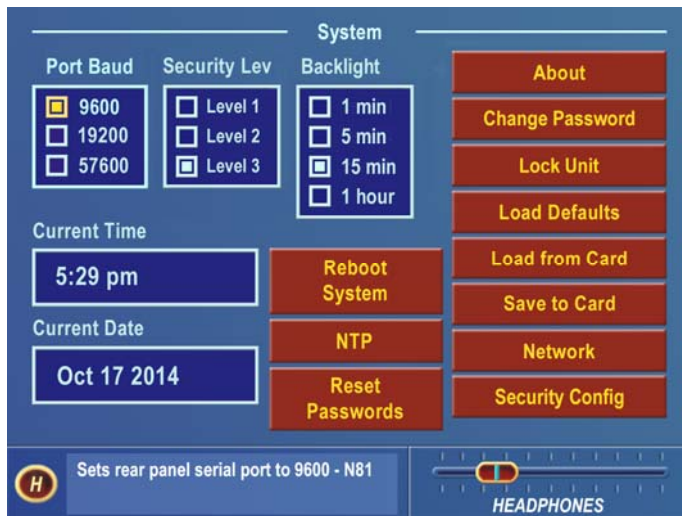

System Submenu

Numerous maintenance and utility functions are found in this submenu. *System* data is saved here, and various *Security* options are available to prevent tampering by unauthorized personnel. There are also controls for setting the serial RS-232 communications baud rate, TCP/IP networking parameters, the date, time, and the Screen Saver backlight off timeout interval. See Pages 44-48 for full details on all the settings in the System Menu.

An important selection under this submenu, *Save to Card*, makes a copy of the Omnia-5EX system configuration, and stores it on the rear-panel PCMCIA card. If a power failure should occur, the unit restarts using the last saved operational settings. This means all Input, Output, Encode and System Menu settings are restored, as well as the previously running processing settings (preset). If the system is not backed up and saved to the PC Card, then the system restores itself to the last known saved set of parameters (which will be the factory defaults if you don't use *Save to Card*!). For this reason, Omnia suggests that you backup the system using the System/Save to Card function after any custom parameter editing has been completed.

## Menu Selections

This section presents detailed information on each submenu window item and the parameter choices or value settings that may be available within them. See Chapter 5, “Fine Tuning Your Sound,” for detailed information on editing processing preset parameters to achieve your custom on-air sound.

This procedure is used for all parameter selection and editing:

1. **Rotate** the jog-wheel to highlight a menu item or submenu item.
2. **Click** the jog-wheel to select that choice or item.
3. If the parameter requires a value, **rotate** the jog-wheel to adjust the value.
5. **Click** to accept the value and return the jog-wheel to Highlight Mode.

## Preset

Also see Pages 64-65 & 78-80 for more on working with Presets.

A short description of each factory preset can also be found in Appendix B starting on Page 114.

This submenu is active under Level-3 password access, or at Security Levels 1 or 2, as defined in the Security Config screen (see Page 47). In addition to the *Preset* name list, there are seven functions available in this submenu: *Choose, Modify, Save Preset, Save Preset As, Compare, Protect* and *Passcode*.

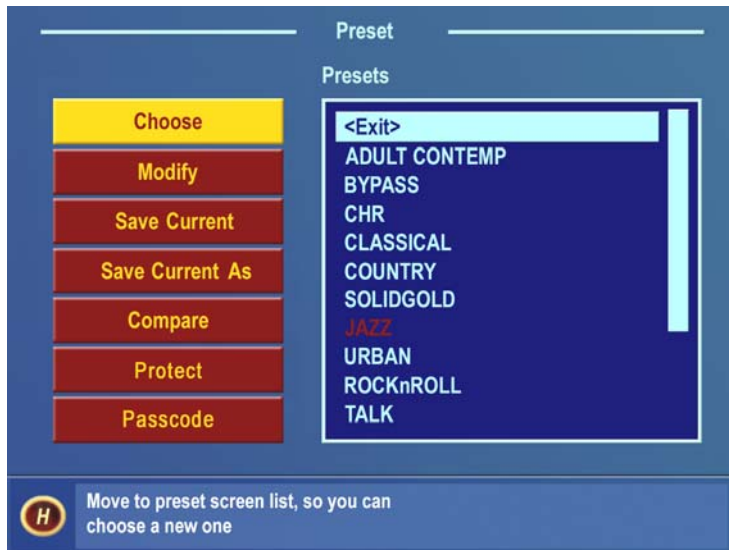

**Preset Submenu**

## Preset List

Lists all of the presets, factory and user, that are on the PC Card inserted into the memory card slot on the rear panel of the Omnia-5EX.

## Choose

To load a preset, highlight the Choose option to move the highlighting to the Preset List, then rotate the jog wheel to highlight the desired preset name and click. The processing algorithms will be updated to the new values almost instantly.

Note: Some of the Factory Presets use lower internal AGC ratios. When switching from any of these (or from User

Presets created using any of these) to another preset, there may be a substantial level drop that will recover over a few seconds. This is normal.

## Modify

Opens the Preset List window so a user preset can be renamed or deleted.

## Save Current

Saves the current parameter settings to the PCMCIA card, overwriting any previous settings saved under the currently running user preset. If the current preset started out as a factory preset but you changed some values, the system will warn you that you cannot save your settings directly over a factory preset name. Instead, you must select the **Save Current As** option, and assign your work a new Preset Name. After doing so, your new Preset will appear in the Preset list.

## Save Current As

Opens up a window so a new preset name can be entered. Preset names can be up to 12 characters in length. The number of presets that can be saved to the PCMCIA card is limited by the Omnia operating system to 50 total presets (including the factory presets). If your preset collection grows larger than the allotted space, you can always save and load presets to and from your PC using the Omnia Remote Software (described in Chapter 6).

Rotating the jog wheel clockwise scrolls through the capital letters of the English alphabet first. Rotating it counter-clockwise scrolls through the numeric characters first, and then through the lower case English alphabet. Click the jog-wheel to select a highlighted character to change. Then rotate the jog-wheel to step through all the possible characters. Once the desired character is displayed, click the jog-wheel to select that character. Rotate the jog wheel to select the next character and edit that as appropriate. When the last character is reached, click to accept the character and then rotate the jog-wheel to highlight the ✓ (checkmark) to save your preset. Highlight the X to cancel naming.

Note: While scrolling through the character list, you will see “Ins”, “Del”, and a blank space. “Ins” stands for “Insert”, and is used when you wish to add an extra character within a preset name. The “Del” option allows you to remove a character or space from a preset name. The blank space is just that. It allows you to add a space within a preset name.

## Compare

Allows two different presets to be compared. This is handy when two presets you want to compare are far apart in the Preset List. Note that preset changes can occur very quickly, but depending on the number of internal parameters being updated, the Compare process may take a second or two to fully transition from one preset to another.

## Protect

Beginning with Front Panel Display software Version 1.0.3.0, it is now possible to protect customer presets with a secret passcode. To use the feature, you must create a custom preset (or recall factory and rename it as your own). The correct order for using the Protect Preset function is as follows:

1. Create a preset and save it as your own (let's use a preset name “TEST33” as an example);
2. Click the “Protect” button in the Preset menu.
3. Enter your passcode (up to six characters), and click on the checkmark to save it.
4. The preset will now be displayed on the screen with a [U] next to it, that is, it will be shown as TEST33[U]. This means that the preset has a passcode assigned to it, but the preset is not yet “locked”.

5. To Lock the preset, go back to the Preset List, click on the “Protect” button, but DO NOT enter a passcode this time – instead just click the Checkmark box. An error message will pop up saying “ERROR: Permission Denied”. Click the “OK” box, and notice that the preset is now listed as TEST33[L]. Your preset is now [L]ocked and secure.
6. Please see the next section for how to access a protected preset.

## Passcode

In order to gain access to a preset that has been protected using the “Protect Preset” utility, the correct passcode for the preset must be entered into the prompt. Please understand that it is impossible for the factory (or anyone else for that matter) to gain access to an Omnia preset that has been encrypted by the Protect Preset utility. Unless the correct key is known (and there is only one), there is no way to recover the preset and its settings!

To access a protected preset for viewing or editing, do the following:

1. Navigate to the Preset Menu;
2. Click on the “Passcode” button.
3. Enter the correct passcode for the preset, noting that the code is case sensitive!
4. The message “sending passcode “XX” should appear. If the code was correct, the preset should display with the [U] (unlocked) symbol next to it.

- OR -

1. Navigate to the Process Menu and click on it;
2. Enter the correct passcode for the preset when prompted for it, noting that the code is case sensitive!
3. The message “sending passcode “XX” should appear. If the code was correct, the preset should display with the [U] (unlocked) symbol next to it and the Process Menu should be accessible.

Additional notes:

- If the preset is protected and the user clicks on the Process menu, they will be prompted for the correct passcode for the preset they wish to edit or view.
- Protected presets may not be viewed, edited, or printed with the remote control program unless the preset is unlocked [U] first.
- The passcode assigned to a preset is permanent. It may never be deleted or changed.
- If more than one preset is protected by a single passcode, entering that passcode at the prompt will unlock ALL of the presets protected that have been protected with that passcode!
- **!! ATTENTION !!** Do not forget your preset passcodes! There is no back door, no secret factory passcode, and no hidden command that anyone can ever use to retrieve an Omnia preset that is locked by an end user. Presets that are locked with the Protect Preset function can only be opened with the correct passcode. The preset data itself is *scrambled* using your passcode as part of a special encryption key. Without the appropriate key, the preset and its contents can *never* be recovered!

## Process

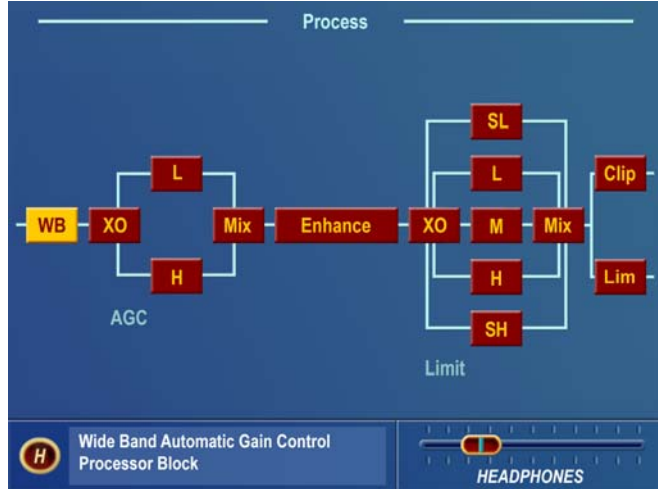

This submenu is a graphical block-diagram representation of the signal flow through the Omnia-5EX. Each block-diagram icon, when highlighted and clicked, opens up a parameter window that pertains to that part of the Omnia-5EX processing circuitry. See Chapter 5, “Fine Tuning Your Sound” starting on Page 60 for an in-depth discussion of using this submenu to edit presets.

## Input

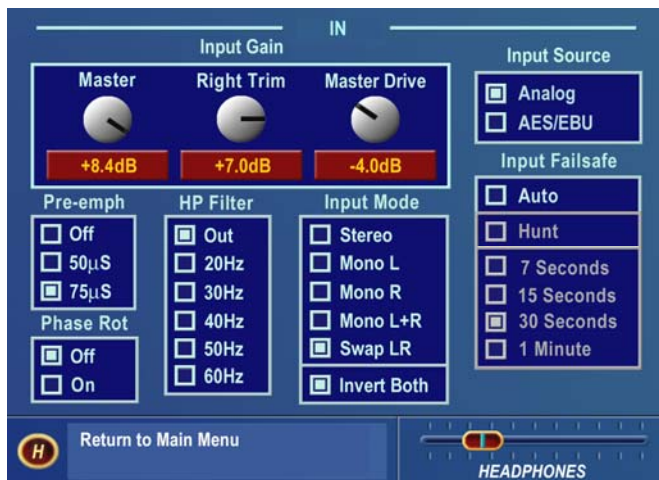

This submenu has seven items:

- Input Gain Master, Right Trim, Master Drive
- Input Source Selection
- Invert Both Channels Option
- Input Mode Selection
- HP Filter Selection
- Phase Rotation Selection
- Pre-Emphasis Selection

### Input Submenu

## Input Gain Master / Right Trim

These controls set both the analog and digital input **peak** levels (simultaneously). For analog and digital signals, the control range is from  $-12.0$  to  $+12.0$  dB of gain. The factory default control setting of  $0.0$  dB corresponds to a maximum peak input level of  $+22$  dBu. To change the input sensitivity, highlight the **Master** (**Not Master Drive**) control and click, then use the jog-wheel to adjust the level in precise  $0.1$  dB steps.  $-12.0$  dB has the least amount of gain;  $+12.0$  dB is the maximum gain. This control adjusts the gain of both the Left and Right channels simultaneously. Compare the setting of this control with the input bargraph meters so that signal **peaks** (the “bouncing balls”) read between  $-12$  and  $-6$  dBFS. To correct any balance errors, use the **Right Trim** control. This control adjusts only the gain of the Right Channel over a limited range of plus or minus  $3$  dB in precise  $0.1$  dB steps.

## Master Drive

This control, located **after** the input bargraph meters, calibrates the nominal internal level of the Omnia-5EX to match the reference level of your air chain. This control should normally stay at 0.0 dB but may need to be adjusted if your station's audio reference (0VU) level is something other than +4dBu. It also may need adjusting if the input audio feeding the Omnia-5EX is primarily pre-processed, such as many recent CD releases that follow the current record industry trend of “hyper-compression”, or if you wish to bypass the *WB AGC* section and there is not enough gain reduction in the *Multi-Band AGC* section. The range of this control is –9dB to +6dB.

Note: Normally there should be 10-12 dB of nominal gain reduction in the *WB AGC* section. This should occur when a +4dBu average (normal program) input level is present and the *Master*, *Right Trim*, *Master Drive*, and *AGC Drive* controls are set at 0.0. If, for example, your audio reference level were +8 dBu instead of +4 dBu, you would set the *Master Drive* control to –4.0 dB. This will optimize the headroom through the unit.

## Input Source

Selects between the discrete Left/Right Analog input or the AES/EBU Digital input.

## Input Mode

Selects how input audio is routed and processed by the Omnia-5EX. Highlight and click on the parameter selection to set the mode. The selected Mode is shown with a dot in the box next to the name. The factory default selection is Stereo. The other available modes are:

**Stereo:** the left and right input channels are processed separately.

**Mono L:** routes the Left Input only through both channels of the processor.

**Mono R:** routes the Right Input only through both channels of the processor.

**Mono L + R:** sums the stereo input to mono and processes the summed audio.

**Swap L / R:** swaps the Left and Right Inputs.

**Invert Both:** if the absolute phase of the Omnia-5EX is different from your existing system, it could cause your announcers to think they sound “weird” while speaking and monitoring themselves with headphones. If this happens, the absolute phase of the Omnia-5EX may be different from what your announcers are used to. A quick way to remedy this is to highlight **Invert Both** and click to select. A dot in the box indicates Invert Both is active.

## Input Failsafe

A new Input Failsafe feature adds functionality requested by many of our customers. In essence, it allows the Omnia to automatically switch its audio input from Digital to Analog (or vice versa) if audio fails on the selected primary Input. To enable this feature, navigate to the Input Menu, highlight the “Auto” checkbox in the Input Failsafe box, and click the jog wheel. A message will appear on the screen to warn you that you have selected the Auto mode, and what behavior to expect. If the Hunt feature is also selected, the Omnia audio inputs will be alternately tried at the interval that is set under the “Hunt” option until a valid audio source is found.

Be aware that there are caveats in the use of the Auto and especially the Hunt features of Input Failsafe that may or may not be suitable for your particular facility! Some caveats are:

1. The presence of program audio, not just valid digital data is used to determine if audio is present on the AES/EBU digital input. Any signal meeting or exceeding the Omnia’s program presence detector threshold of –37.5dBFS is accepted as valid audio.

2. For both the Digital and Analog inputs, an “Audio failure” is defined as “any audio level remaining at or below -37.5dBFS for at least 7 seconds”.
3. Audio must have actually been ‘detected’ first on an input before the Hunt process can function. Said another way, if the Omnia is sitting on the workbench with no audio applied and the Auto and Hunt options are enabled, nothing will happen. The Omnia needs to see valid audio FIRST before it can detect the absence of audio and begin the Auto switch phase.

Note that the Input meters and Input Menu Source indications will change to follow the Input Source that is currently selected whether it be manually selected by the user or controlled by the Auto Switch function.

## High-Pass Filter

In most FM systems, subsonic frequencies in the input audio program should usually be rolled off to prevent difficulties with certain exciters and STL systems. The Omnia-5EX has a third-order (18dB/Octave) high pass filter with five selectable cutoff frequencies from 60 Hz down to 20 Hz. The factory default is “Out”, which means that audio frequencies to well below 2Hz are passed through the system without attenuation. You may select one of the other values that may be more appropriate for your system.

## Phase Rotator

This section consists of two, cascaded second order 200 Hz all pass filter sections. Phase Rotators (also known as Phase Scramblers) are commonly utilized to make asymmetrical waveforms (such as voice) more symmetrical. This ensures that clipping occurs equally on positive and negative peaks, making better use of the symmetrical nature of the FM modulation process. Phase rotation can make talent voice sound cleaner, but since it disturbs the phase integrity of musical signals, music might sound more faithful to the original source if phase rotation is not used. **Off** can be chosen if previous phase rotation has been performed in your system (in a microphone processor for example) or to preserve the phase integrity of the original program as described above.

## Pre-Emphasis (FM Mode Only)

For the transmission side of conventional FM broadcasting, some form of high-frequency boost, or pre-emphasis is used. The most commonly used values of pre-emphasis are 50 and 75  $\mu$ s (microseconds). For North and South America, 75  $\mu$ s is used. In Europe, Australia and New Zealand, 50  $\mu$ s is employed. The factory default pre-emphasis setting is 75  $\mu$ s. The pre-emphasis selection affects the operation of the audio processing and is applied to the composite, discrete, and digital outputs. The pre-emphasized signal at the Left/Right and digital outputs can be restored to flat, if needed, by the **De-Emphasis** parameter selection.

To set the Pre-Emphasis, rotate the jog-wheel to highlight one of the three choices: **Off**, **50  $\mu$ s** or **75  $\mu$ s**. Click the jog-wheel to set the pre-emphasis selection.

**Note:** Normally, the **Off** selection under the Pre-emphasis options would not be used in conventional FM transmission applications, but is provided in instances where processing of a flat signal is desired. One example would be when preprocessing prior to a satellite uplink in distributed radio networks.

# Output

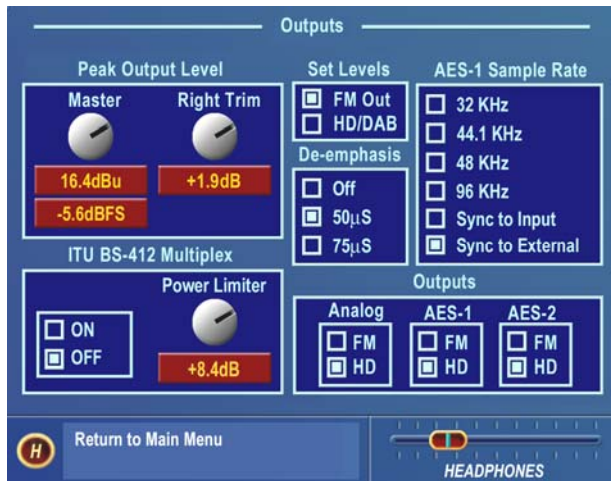

Output Submenu

There are six settings under this menu item:

- Peak Output Level
- Set Levels
- AES-1 Output Sample Rate
- De-Emphasis
- ITU BS-412 Multiplex Power Limiter
- Outputs (Limiter Routing)

## Peak Output Level

The peak output level adjustment is done using the **Master** output control. This sets both the Left/Right outputs in tandem. If there is a variance in output level between the Left/Right channels, the **Right Trim** is used to balance the peak output levels. These level settings take place in the digital domain and before any D/A converters. Therefore, the output level settings affect the digital (AES/EBU) outputs and the analog outputs, including the headphones (but **not** the Composite MPX outputs). Conventional FM and HD/DAB levels are adjusted separately. (See **Set Levels** below) The control range is from  $-2.0$  dBu ( $-24$  dBFS) to  $+22$  dBu (0dBFS) **peak** output level in precise 0.1 dB steps. Since the Omnia defines the absolute peak levels prior to this control, this level control is normally set to the maximum acceptable input level, or just below it, of the device that Omnia-5EX is driving (STL, transmitter, etc). No offset for headroom in the following system is required.

## Set Levels

This function determines which output the *Peak Output Level* controls operate. When **FM Out** is selected, the controls set the conventional FM output levels. This level is also sent to the Output Bargraphs on the Left LCD screen. When **HD/DAB** is selected, the adjustment controls and bargraphs are set to adjust and monitor the output of the Look Ahead limiter.

## AES-1 Sample Rate

One of four standard digital sample rates (32, 44.1, 48 and 96 kHz) can be selected for the AES-1 digital output. The output sample rate can also follow the incoming sample rate on the digital input, or lock to the External AES Sync Input sample rate.

Note: The output sample rate for the AES-2 digital output is also adjustable by using hardware jumpers on the internal SRC (Sample Rate Converter) board (see Pg.59). AES-2 can also be locked to whatever the AES-1 Output is set to, as well as synchronized to AES-1 if it is being synchronized by an external AES3 source.

## De-Emphasis (FM Mode Only)

The Left/Right FM mode outputs are pre-emphasized under normal circumstances, such as when feeding an outboard stereo generator or discrete microwave studio-transmitter link. The same applies when feeding a digital exciter from the AES/EBU output. These outputs can also be de-emphasized for installations that require a flat frequency response, as is the case when feeding other types of studio to transmitter links or for monitoring.

*Omnia-5EX Use and Operation Manual – V: 1.1*



To change the De-Emphasis setting, rotate the jog-wheel to highlight one of the three choices: *Off*, *50 μs* or *75 μs*. Click the jog-wheel to set the de-emphasis selection. If choosing a de-emphasis time constant, it should match the pre-emphasis time constant. Bear in mind that if Pre-Emphasis is turned on, selecting *De-Emphasis Off* means that the outputs will be pre-emphasized. **Note:** The *De-Emphasis* setting does not affect the composite MPX outputs, which always follow the *Pre-Emphasis* setting.

**Note:** The headphone output is automatically appropriately de-emphasized when any value of pre-emphasis is being used.

## Outputs

Think of this as a simple router. It enables either the *FM* or *HD/DAB* output signals to be routed to whichever physical output is desired: the Analog, AES-1, or AES-2 connectors. The analog output (including the Headphones) can be assigned to either the conventional FM, or the HD/DAB output for monitoring purposes.

## Power Limiting (FM Mode Only)

In certain parts of the world, the average multiplex signal power must be controlled to reduce adjacent channel interference. The currently enforced standard falls under the ITU BS-412 regulations. The Omnia-5EX has a very effective Multiplex Power Limiter that may be enabled to comply with these regulations.

The Power Limiter control sets the average multiplex power from 0.0dB up to 9.0dB (in 0.25dB steps) above the original 0.0dB ITU BS-412 standard. The default setting is *Off*.

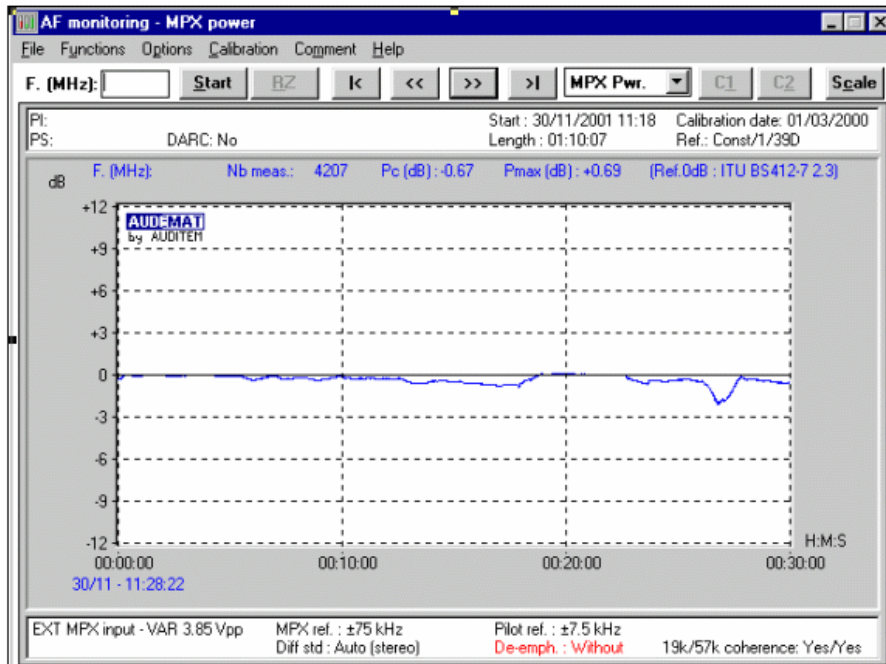

**Effectiveness of the Omnia's ITU BS-412 Power Limiter**

## **Loudness Loss Warning!**

If your country's regulatory agency does not require the use of the ITU BS-412 Multiplex Power Limiter, make certain that the BS-412 Power Limiter is set to **off**, or severe loss of loudness will result! For example, when the ITU BS-412 Power Limiter is switched on and set at 0.0dB, there is approximately a FIVE dB loudness loss over the limiter being switched off!

## Encode (FM Mode Only)

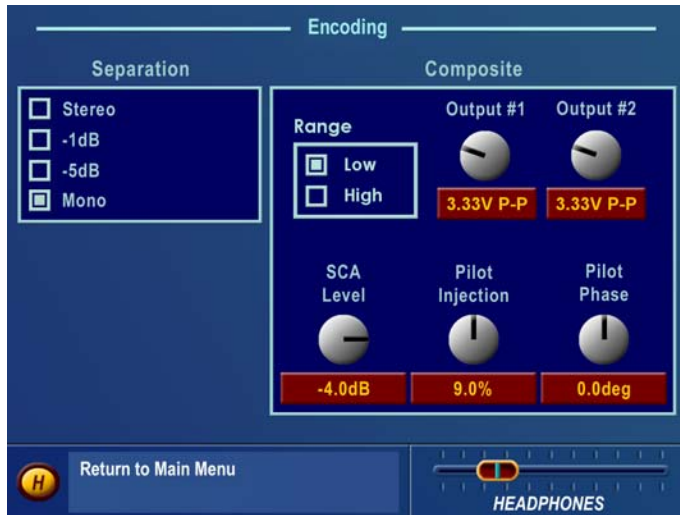

Encode Submenu

Seven parameters are set under this submenu:

- Composite Range
- Composite Output 1
- Composite Output 2
- SCA Level
- Pilot Injection
- Pilot Phase
- Stereo Separation

### Composite Output #1, Output #2 and Range

The Output controls individually set the level at the two separately buffered rear-panel composite outputs. When Range is set to **Low**, both Output controls will adjust between 0.66 and 5.02 volts peak to peak. When Range is set to **High**, both Output controls will adjust between 1.45 and 11.02 volts peak to peak. Use the jog-wheel to select the modulation level for each composite output. Once the desired peak modulation level is displayed, click the jog-wheel to set the level and return to Highlight Mode.

Always use typical program material and a calibrated modulation monitor to properly set modulation. To aid quick adjustment, it sometimes helps to advance the Clipping control before adjusting the composite outputs. Note that reference line-up tones applied at the Omnia-5EX input cannot be used since the RMS level of a steady state tone does not *crest* at 100% modulation.

### SCA Level

Sets the SCA subcarrier deviation level. This adjustment should always be done using a calibrated modulation monitor.

**Note:** Adjusting the *Composite Outputs* changes the SCA deviation level since the two output controls are effectively in series. Always recheck the *SCA Level* adjustment after making adjustments to the *Composite* outputs.

### Pilot Injection

Sets the pilot level from 6% to 12%, in 0.1% steps, relative to 100% modulation. To defeat the pilot, simply adjust the Pilot Injection control below 6% and the control indicates **Off**.

### Pilot Phase

This parameter sets the phase relationship between the 19 kHz pilot and the 38 kHz suppressed carrier. The system default is 0.0°. The performance of the DSP based digital stereo generator is theoretically perfect, however should the phase need adjustment in order to offset time domain errors in the overall transmission system, the pilot phase can be adjusted  $\pm 32^\circ$ , in  $2^\circ$  increments. We recommend that a calibrated modulation monitor be used for this adjustment. If one is not available, the tried and true “bow tie” method using an out-of-phase 100 Hz tone and oscilloscope will suffice. If you are not familiar with this method, contact Omnia tech support for details.

## Separation

The stereo “sound field” can be reduced by 3 dB or 6 dB to suppress processing-induced multipath that can occur in certain terrain and within certain transmission systems when heavy processing is used. When a setting of -3 dB or -6 dB is used, the amount of L-R (perceived stereo effect) is also reduced. However in difficult RF signal coverage areas, the amount of perceived multipath is reduced as well, resulting in the perception of a much cleaner overall signal with better penetration and coverage. The Omnia-5EX defaults to a setting of *Stereo*, using the full L-R signal. We suggest that you leave it in that mode, but the other settings are available for those who wish to experiment, including a setting of *Mono*.

## Schedule

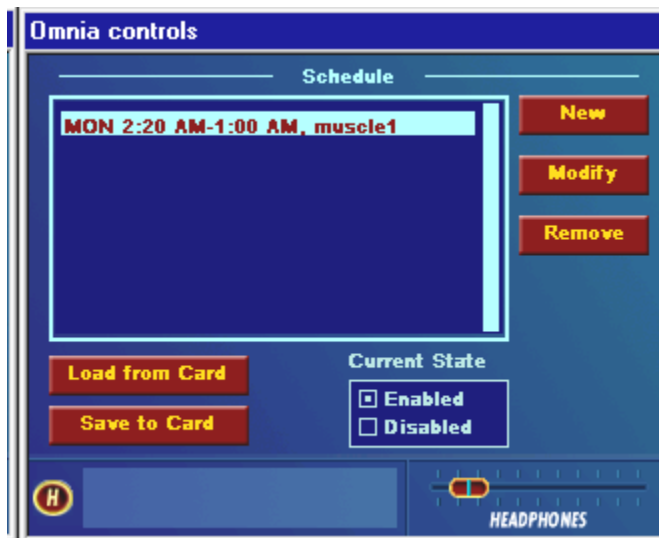

Schedule Submenu

This submenu allows you to create and maintain Schedules (Daypart Tables). A schedule is used to automatically load or change presets according to the day and/or time of day. The start day can be any specific day of the week, weekdays (M-F), weekends (S-S), or every day (All). All dayparts must end within a 24-hour period. Over 450 individual events can be programmed within a 7-day interval.

## Schedule List

Previously saved Schedule files are listed in the window. To select a schedule, highlight and click on the schedule name.

## New

Used to create a new Schedule. Highlight and click on *New* to open the Modify Schedule window and create a new Daypart Schedule.

## Modify and Remove

Used to modify or remove an existing schedule. Highlight and click on the Schedule List, then highlight and click on the Daypart Schedule you wish to modify. Highlight and click on *Modify* or *Remove*. *Modify* will open up the Modify Schedule window and allow you to modify the settings of the selected daypart. *Remove* will bring up a confirmation dialog asking if you want to delete the selected daypart. Answering *Yes* to the prompt permanently deletes that Schedule from the system memory.

## Load from Card

Retrieves Schedule/Daypart data stored on the Omnia PC Card. This operation will restore any dayparts that were previously saved to the card with the *Save to Card* operation, described next.

## Save to Card

Stores the Schedule and daypart information on the Omnia PC Card. You might do this for safety or even for sharing the data with other Omnia-5EX processors. It saves all of the currently defined dayparts and the daypart state to the Omnia PC card. These settings can be loaded later by selecting *Load from Card*.

## Current State

Turns the Schedule function on and off. When Disabled, the Scheduler runs but does not load presets. When Enabled the Scheduler automatically loads presets following the daypart schedule that is set up in the current Schedule.

## System

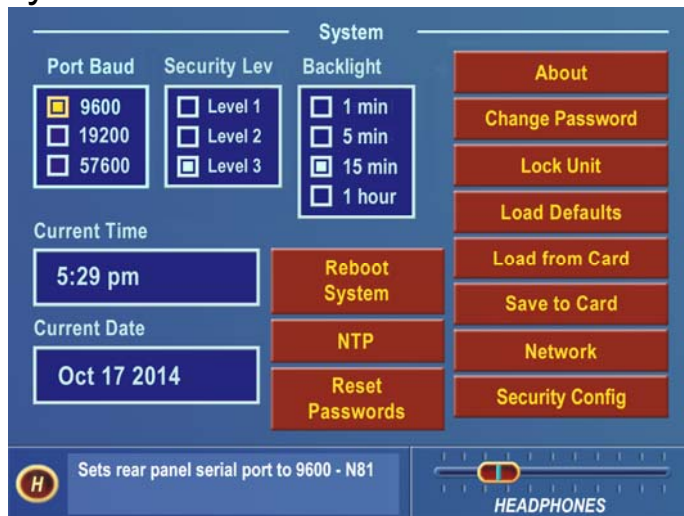

This submenu allows you to perform housekeeping on the Omnia-5EX operating system. Many items on this menu are available only to those having Level 3 security access. There are sixteen parameters or selections: About, Change Password, Lock Unit, Load Defaults, Load from Card, Save to Card, Network, Security Config, Current Time, Current Date, Port Baud, Security Level, Backlight, Reboot System, NTP, and Reset Passwords.

### System Submenu

## Port Baud

This option sets the rear panel RS-232 communications port parameters between 9,600 baud, 19,200 baud and 57,600 baud. The factory default is 19,200 baud.

## Security Lev(el)

It is advisable for the user interface to be password-protected for controlled access. There are three levels of password protection:

In levels 1 and 2, the visibility of each submenu (except System) can be set in the Security Config screen. (See Page 47)

Level 1, User, allows access only to the Menus selected in the Security Config window, parts of the System Menu and the headphone level control. The default password for this level is “user” (all lower case).

Level 2, Advanced User, allows access only to the Menus selected in the Security Config window, parts of the System Menu and the headphone level control. The default password for this level is “advuser” (all lower case).

Level 3, Master or Engineer level, allows access to all submenus. The default password for this level is “engineer” (all lower case).

There is a “Stealth Mode” option that suppresses the gain reduction metering and the current Preset Name when the Omnia-5EX has been locked. The I/O metering continues to function normally, and the currently running Preset Name is replaced by the text “System is Locked”. See the Security Config section below for details.

It is advisable to change the passwords once the Omnia-5EX is installed. Passwords are case sensitive and can contain up to ten characters. See the Change Password section below for details.

## Backlight

This setting determines the time it takes for the LCD screens to turn off after the last time the jog wheel has been used. The selections are 5 min, 15 min or 1 hour. To preserve the life of the LCD backlight, there is no option available for continuous operation.

## Set Time

Sets the current time for the unit, which must be set before dayparts can be used. The time is set using the familiar “turn and push” action of the jog-wheel.

**Note:** The time can be synchronized to “:00” seconds by pressing the jog wheel in synchronization with the seconds indicator of an external clock. To maintain accurate dayparting, you should periodically reset the internal clock to your external reference. The Real Time Clock IC used in the Omnia-5EX typically has an accuracy of better than +/- 0.5 minutes per month.

**Note:** An additional menu will prompt you to set the unit to Daylight Saving or Standard time.

Note: There is now an NTP time function available, which can synchronize the Omnia time to an external source connected to its Ethernet jack. This time can be from a local GPS based device (for instance) or from a connection to the Internet. See the NTP section below for more details.

## Set Date

Sets the current date, which needs to be done before daypart scheduling can be used. The date is set using the familiar “turn and push” action of the jog wheel.

## About

Displays a window listing the system software versions that are currently loaded and running.

## Change Password

Opens up a window so that the selected Security Level password can be changed. **The factory default passwords are:**

Level 1 – **user** (all lower case)

Level 2 – **advuser** (all lower case)

Level 3 – **engineer** (all lower case)

To change a password, use the standard click and turn of the jog-wheel to select the character position you wish to change and to select the new character for that position.

After entering a new password, highlight the **checkmark** and click the jog-wheel to save the password. If you wish to cancel the operation, highlight the “**X**” and click the jog-wheel.

**Caution:** Passwords for each level **must** be unique. Do **not** assign the same password to multiple security levels! You will lock yourself out of the unit!

## Lock Unit

Highlight and click to immediately lock the unit. A confirmation dialog will pop up asking you if you are sure you wish to lock the unit. If you click yes, a dialog box is presented for password entry to unlock the unit.

## Resetting the Omnia-5EX Passwords to their Factory Defaults

If you do manage to lock yourself out or you have simply forgotten your password, Omnia Technical Support can assist you in unlocking your Omnia-5EX. The Telos / Omnia Customer Support Team can generate a special code for you which, when entered into the Login Password dialog box, unlocks your unit and resets all passwords to their factory defaults. You will need to have your Omnia-5EX's MAC address (found on the rear panel barcode sticker starting with 0050C) and the currently displayed Date (visible just below the Login Password dialog box. Once presented with this information, Omnia Customer Support will give you a special code to type into the Login Password dialog box, which will unlock your unit and restore all of the factory default passwords. Note that this special password is unique to your unit and effective only for the day on which you call Omnia Customer Support to obtain it.

## Load Defaults

Reloads all of the factory default system parameters into the system. All Input & Output levels and other System parameters are reset back to their factory default settings.

## Load From Card

Allows the system settings (essentially all of the internal parameters except those in the Process Menu), to be loaded into the system from the PC Card. When this option has been selected, carefully follow the instructions presented on the LCD screen to perform this function.

## Save To Card

This option creates a backup of your system settings to the rear panel PCMCIA memory card. All parameters *except* those in the Process Menu are included in the System settings. Occasionally doing this is a good safety practice that creates a backup of your data and data that is also stored in the nonvolatile RAM within the Omnia-5EX. When selected, a dialog box appears, asking you to confirm the overwriting of the current system file.

## Reboot System

This option will reboot the entire system.

**Warning:** Using Reboot System will cause Audio Interruption for about 10 seconds as the unit reboots.

## Reset Passwords

If front panel passwords for levels 1 and / or 2 are lost or forgotten, it is possible to reset the Omnia's passwords back to their factory defaults. When the Reset Passwords box is clicked, you will be prompted for the current level 3 password. Note that the level three password will also be reset to the factory default if this option is used.

## Security Config(uration)

Under the Security Configuration screen you can assign what submenus may be accessed at password Levels 1 and 2, the lesser security levels. The Level 3 security level is the Master security level, and ALL submenus and functions may be accessed at that level.

**Important Note:** Be sure to click **Save Changes** before exiting this menu or any changes made will not take effect!

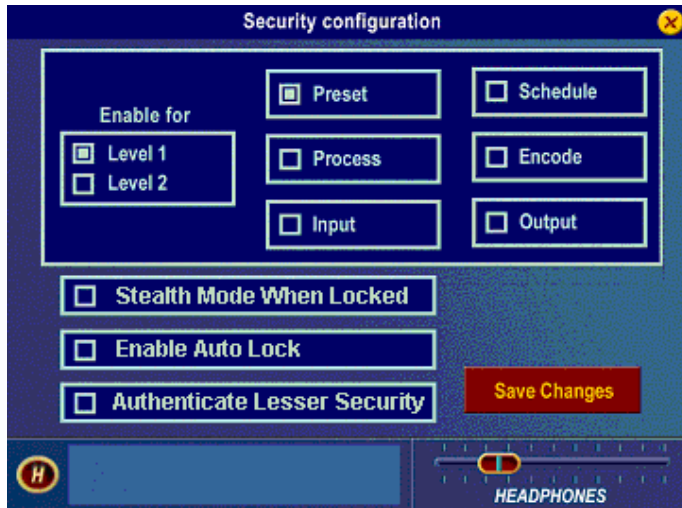

The “**Stealth Mode When Locked**” option causes the processing bargraph gain reduction metering to stop and the selected preset name to be hidden from view when the Omnia is locked.

The “**Enable Auto Lock**” option causes the unit to be automatically locked whenever the screen saver activates.

The “**Authenticate Lesser Security**” option gives the user the ability to have the Omnia prompt for passwords regardless of which direction the security level is being changed.

**Security Config Submenu**

## NTP

The Omnia now has the NTP (Network Time Protocol) function built in to enable it to retrieve the time of day from an external source and keep the Omnia’s clock set very accurately over the long term. Both long and short term timekeeping are enhanced by this feature. With NTP time, the Omnia’s clock can be accurate to a few fractions of a second. Accurate sources of network time within the United States can be found at:

<http://www.boulder.nist.gov/timefreq/service/time-servers.html>.

A list of potentially useful International NTP servers can be found at:

<http://www.eecis.udel.edu/~mills/ntp/clock1a.html>

We’re sorry, but we cannot vouch for the availability and absolute accuracy of the International NTP sites.

No matter what source you use, be sure to set the UTC offset to be correct for your particular time zone!

To enable the NTP function: Enter a valid NTP IP address and your correct local time zone offset (from UTC) in the boxes and click the **Save and Update** button. If the Omnia can reach the NTP Time Server that you have selected, a dialog should pop up with confirmation that Omnia Time was successfully synchronized to NTP server time. If it cannot reach the NTP server, an error (Error: No response from NTP Server) will be displayed to notify you of this fact.

To disable the NTP function: Simply clear the IP address box and click the Save and Update button.



# Network

Opens up a window to set the Ethernet communications protocols. (IP address, default Gateway and Subnet Mask)

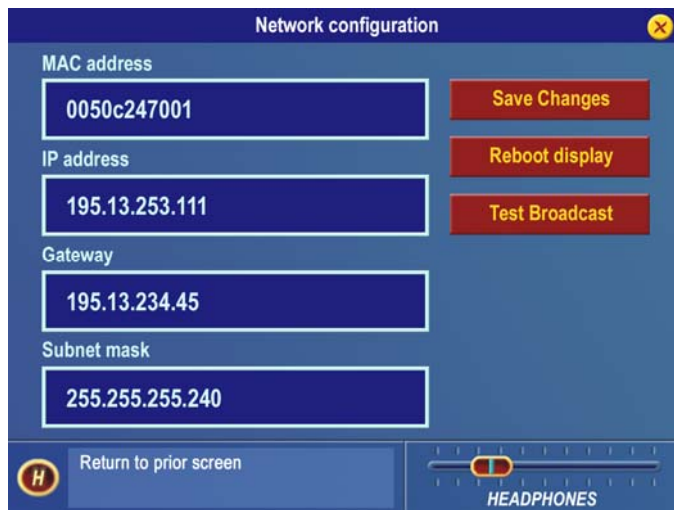

**Important Note:** Be sure to click **Save Changes** before exiting this menu or any changes made will not take effect!

There are also options to Reboot Display (front panel only, without affecting the audio) and send a Test Broadcast packet out to the connected network.

**Network Submenu**

## MAC Address

The factory assigned, twelve-digit, hexadecimal hardware address of the Omnia-5EX Ethernet interface.

## IP Address

The customer assigned TCP/IP address of the Omnia-5EX Ethernet interface. See your IT department if you aren't certain how to configure this parameter.

## Gateway

The gateway setting must match your network gateway. See your IT department if you aren't certain how to configure this parameter.

## Subnet Mask

The subnet mask setting must match your network gateway. See your IT department if you aren't certain how to configure this parameter.

## Save Changes

After changes have been made to the network configuration, they must be saved in order to be able to be recalled at next power up.

## Reboot Display

In front panel software versions prior to version 1.0.3.4, the front panel must be rebooted after making changes to the network configuration. This reboot only affects the front panel and will not interrupt the audio. Note that in software version 1.0.3.4 and later, a front panel reboot is not required when changing network parameters.

## Test Broadcast

The Test Broadcast button sends a series of UDP packets out over the network interface. The message contained in the packets is "An Omnia Broadcast Datagram". These test packets may be used to troubleshoot routing and other issues on the customer's network.



# Chapter-3: The Omnia-5EX: Audio Processing Overview

This section presents an overview of the Omnia-5EX processor. Refer to the block diagram shown on the Process submenu to provide a functional order to the various processing sections. Full details about all of the individual controls in the Process submenu can be found in Chapter 5: “Fine Tuning Your Sound” starting on Page 60.

**Note:** More detailed technical information about the audio processing employed in Omnia-5EX can be found in the Technical Papers section on the Omnia web site ([www.omniaaudio.com](http://www.omniaaudio.com)).

Your Omnia-5EX comprises ten general processing sections as shown below.

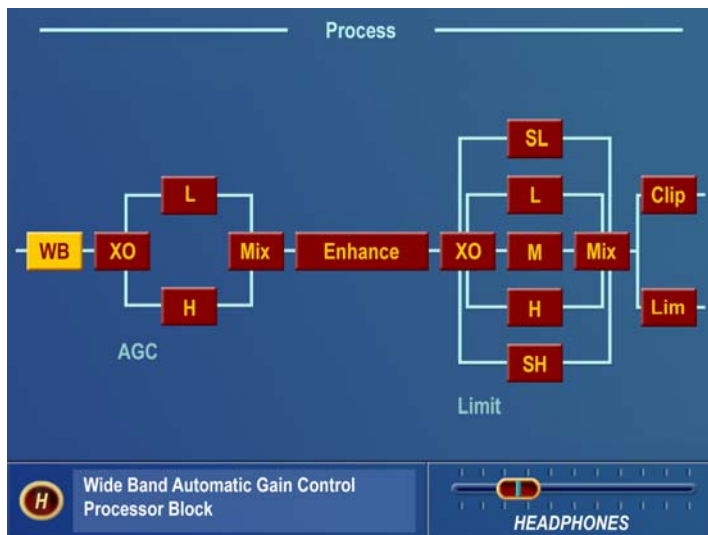

## Process Menu Block and Signal Flow Diagram

Following is a list of these sections, followed by an explanation of their functions. The name of the process block as displayed on the Omnia-5EX menu is shown in parenthesis.

1. An input Wideband AGC circuit for initial level control (WB),
2. A two-band cross-over (XO) for...
3. A two-band AGC (L, H),
4. A mixer circuit (Mix) to combine the signals from the two-band AGC,
5. A bass and stereo enhancement section (Enhance),
6. A five-band crossover (XO) for the limiter sections,
7. Five limiters (SL, L, M, H, SH),
8. A final summing mixer (Mix), and
9. Multiple clipper stages (Clip) at the conventional FM output.
10. Look Ahead Limiter for the HD/DAB output.

**Wideband AGC:** A very flexible wideband leveler section provides smooth, transparent control of the input program. This is achieved through two significant Omnia innovations, a dual referenced release gate and a hidden, intelligent “makeup” gain algorithm. The dual gate reference is a unique process that correlates the dynamics of the audio input signal to a “rolling” reference level, and from that information makes conditional decisions affecting the character of the release function.

A user-adjustable Make-Up Gain feature incorporates a hidden control signal that determines when the amplitude of the input program suddenly falls to a reduced level. It then adjusts the side chain gain in order to quickly “fill in” the softer program passages so that the average level is increased. This allows the AGC function to operate with slower overall time constants, while significantly increasing the average audio level. Slower “average” time constants yield lower intermodulation distortion, contributing to Omnia’s trademark sound.

Using Classical music for an example, the orchestra often plays *forte*, and then enters abruptly into a quiet passage. Conventional AGC algorithms would hold the softer passage down until it was able to slowly recover at the static release time setting, making such passages nearly inaudible at normal listening levels. Omnia-5EX’s *makeup gain* function allows a hidden, faster time constant to provide quick recovery, but *only during the softer passage*. As soon as the orchestra starts to play louder, the “makeup” time constant yields control back to the primary AGC circuit, returning gain to the previous platform level. This sophistication preserves the dynamic integrity of the signal while greatly enhancing the listenability of the program.

A built-in, multi-stage phase rotator ensures symmetrical clipping of positive and negative peaks, making better use of the symmetrical limitations of the FM medium. (This feature may be defeated for a more musically transparent sound at the expense of possibly increased distortion on certain voice material.)

**Phase Linear, Time Aligned Crossovers:** Most multiband audio processors make a compromise in the crossover area in order to provide a flat dynamic frequency response. This is done to avoid audible peaks or dips in the recombined frequency response as the individual band gains change during processing. In an effort to minimize this problem, most processors use a fixed phase-offset in the crossovers. While such treatment helps to minimize frequency response peaks and dips, it also results in a loss of phase linearity, increasing “smearing”, and reducing musical clarity.

In Omnia-5EX’s DSP implementation, the crossover networks are carefully time-aligned so that the recombined spectrum remains flat, regardless of the amount of gain control being applied within any band. This true phase linear response assures that harmonic overtones are not displaced in time. The result: that truer, more natural, and more musical “Omnia sound”.

Additionally, Omnia-5EX features separate crossovers for the multiband AGC sections. The limiter section contains its own five-way crossover with factory optimized non-adjustable crossover frequencies and slopes.

**Two-Band AGC:** Similar in character to the wideband AGC described above, but with two bands, this section has the ability to add power and loudness to the audio while tailoring and pre-processing it for delivery to the enhancement and multiband limiter sections. Each of the four crossover frequencies has five user-adjustable settings.

**Enhance:** This section contains the Bass EQ and Stereo Enhancement controls. In the Omnia-5EX’s unique signal processing architecture, these controls are placed in their optimal position — between the multi-band AGC and Limiter sections.

**Deep Bass EQ:** For those who demand *thunderous* bass. Up to 12 dB of “thunder” can be added to shake your listeners’ walls! This is not merely a simple bass EQ, but a sophisticated concept, which considers the time alignment of low frequencies as they pass through the entire system. This allows loud, clean, thunderous low end, with no sacrifice to the overall loudness of your signal. Deep Bass is a shelf boost at 85 Hz that utilizes a phase linear 12 dB per octave slope to produce the shelving EQ function.

**Phat Bass EQ:** Phat Bass is a unique enhancement that adds filtered harmonics to the bass frequencies, carefully weighted to deliver its effect during the initial rise time of the low frequencies. Low frequency texture is emphasized with this control; the resulting effect is that older recorded materials sound fuller (or “phatter”) with the illusion of added loudness. The pleasing low frequency harmonics generated by the Omnia's Phat Bass algorithm helps your station sound bigger and fuller on radios with smaller speakers, such as portable or desktop radios. This gives your listeners the illusion of deeper bass response from their radios than they're actually capable of.

**Warmth EQ:** The Warm Bass parameter is a second order shelf boost with a corner frequency of 150 Hz. Warm Bass compensates for program material that is naturally lacking in upper-bass punch. The parameter is adjustable over a 6 dB range.

**Stereo EXP:** This is a DSP stereo enhancement effect that enhances the stereo sound field without unwanted side effects such as unnatural imaging or exaggerated multipath. Program audio previously lacking in stereo width will have noticeably increased ambiance, depth and dimension when Stereo EXP is active. Vocals stay up-front and the sonic details of musical instruments are heard with an apparent slight loudness increase when listening in stereo. The stereo width is automatically controlled to avoid over-enhancement.

**Multiband Dynamic Peak Limiter:** Not just simple limiter sections using single time constants, but rather a sophisticated series of processes, which make automatic adjustments based upon the “peak weight” of the signal. These advanced algorithms rely upon *peak-weighted* calculations to determine the strength of a transient peak, which then determines if very fast dynamic control is required. Faster time constants are used only when necessary, and then only under certain conditions that are dictated by the density of the signal. A built-in release *Hold* algorithm allows the limiter to rest momentarily in order to significantly reduce IM distortion.

For maximum clarity and punch, the system uses different algorithms for each of the bands: The super low, low and mid bands use a *feedback* limiter configuration, producing a larger, warmer sound on the lower frequencies. The high and super high bands utilize a *feedforward* limiter design that maintains a more open, natural and musical texture on higher frequencies. The user may adjust the individual limiter thresholds, their hold threshold values, as well as each band's attack and release times. The limiter behavior has been optimized by fixed crossover frequencies of 120Hz, 480Hz, 1.6kHz, and 6.2kHz.

**Non-Aliasing, Distortion Controlled Final Limiter/Clipper (Conventional FM):** Typically, the clipper section is where previous attempts at DSP-based clippers have failed. The term “digital grunge” and “that digital sound” came from early DSP based attempts at simple peak clippers. Omnia-5EX’s proprietary DSP-based clipper algorithm generates no in-band aliasing artifacts, and reduced audible processing distortion while producing a clean and very loud signal. Users have reported that this implementation exceeds the “smoothness” of a well-designed analog limiter! Parameter adjustments include *Clipper Drive*, *Bass Clip Threshold*, *Clipper Silk* and *Composite Clipper Drive*.

**Look Ahead Limiter (HD/DAB):** The input for this stage comes from the output of the multiband limiters mixer, and it is used instead of the clipping process that the FM output utilizes. Typically, HD Radio and DAB employ data reducing encoders for transmission. Experience has shown that a clipped audio signal generates added coding artifacts due to the harmonic content of a clipper and increased workload on the coder. A Look Ahead limiter greatly reduces harmonic content over that of a clipper, dramatically improving coder performance. Precise peak control is still obtained using the Look Ahead limiter. This function provides audio frequency response out to as much as 20kHz, but an adjustable low pass filter is provided should the need for narrower bandwidths be required.

**Stereo Generator / Encoder (Conventional FM):** All-digital numeric implementation - theoretically perfect performance is approached. Stereo separation is typically greater than 65 dB. Suppression of the 38 kHz subcarrier is greater than 75 dB. User parameters include *Separation*, *Pilot Phase*, *Pilot Level* and *Composite Output Level*.

**Selectable Composite Clipper with Phase Linear Composite Low Pass Filter (Conventional FM):** This feature is useful for those who wish to “turbo-charge” their FM signal. This clipper is specially designed to not interfere with the 19 kHz stereo pilot. There is also a digital implementation of the *Dividend* Composite Filter, which allows composite processing to be used without generating any harmonic content in the SCA spectrum. With 3 dB of composite processing employed, all content above 53 kHz is suppressed by 75 dB. This precise spectral management contributes to loudness, ensuring that no wasted energy is transmitted.

New in Omnia-5EX is a pilot notch filter to protect the pilot region from clipper artifacts. The wide, deep notch helps the stereo pilot region stay immaculately clean, reducing multipath, and keeping receiver's stereo decoders firmly locked to your signal. (Some radios “look” at the pilot region to determine when to activate their blend to mono and/or high frequency roll off functions.)

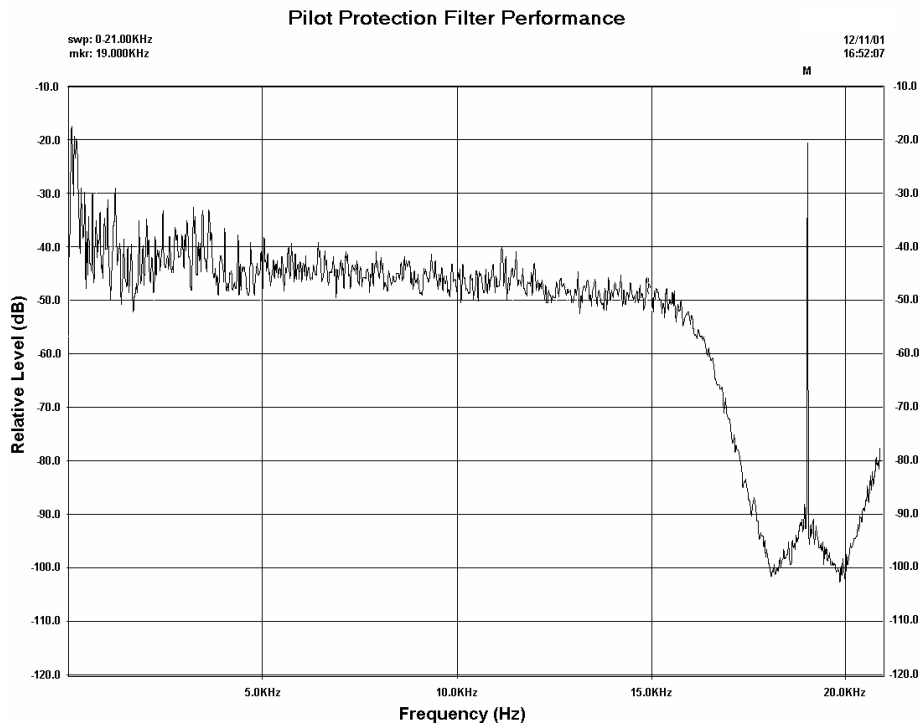

# Chapter-4: Processor Interfacing

This chapter presents installation and operation information specific to the Omnia-5EX. A Parameters Worksheet, on Page 120, may be photocopied to record the parameter settings used for specific processing presets.

## Processor Location

Believe or not, this is an important consideration! Where you choose to locate the processor—at the studio or at the transmitter—can have a profound impact on the overall performance and your stations' loudness on the dial. We present a few considerations that will aid in making this decision.

In most applications, installing the processor at the transmitter site provides a solid coupling between the processor and the FM exciter. Since there is no other transmission link between the processor and the exciter to degrade the tightly controlled peak output levels, modulation performance and therefore competitive loudness, will be maximized. The drawback to this setup is that the processor is located in what is usually a remote, acoustically noisy, and electrically unfriendly environment. Omnia-5EX remote control can be used to make processing changes from elsewhere.

While numerous options for processor location are provided in the next section, we recommend that Omnia-5EX be located at the transmitter site for any HD Radio/DAB installation. The key issue that must be considered is that Omnia-5EX creates two distinctly different processed outputs for the transmitter(s). Unless your STL link is capable of transporting these signals in a 100% transparent manner, then your best performance will occur when the processor is located at the transmitting facility.

If you plan to set up the processor at the studio, consideration must be given to these STL factors:

## Analog STL Use

- Is the STL path a clean shot? If the path is noisy, or is plagued by fades, multipath, or other types of interference (especially if a composite STL is used), unwanted noise will be added to your signal, robbing you of loudness.
- Is the STL a Discrete or Composite system? If a discrete system is used, there must be a provision for a stereo generator/encoder at the transmitter. In that instance, it is imperative that this stereo generator/encoder not introduce any distortion or overshoot into the system. Most stand-alone stereo generator/encoders employ some form of low pass filter and safety clipper. These sections can add significant distortion and modulation overshoot if not set up properly. If a composite STL is used, the multiplexed output of the Omnia-5EX can be connected directly to the STL. At the transmitter location, the composite receiver can be directly connected to the exciter.
- Overshoots: Some analog STL systems, especially those manufactured before 1990, can generate significant overshoots due to several possible design deficiencies. Subsonic “bounce” can be caused by an AC coupled modulator/demodulator in the STL system, and this alone can cause 1 - 2 dB of lost loudness. One method of verifying that a composite STL system is free of overshoots is to connect an oscilloscope to the STL receiver and monitor the composite waveform, paying special attention to the integrity of the low frequency square waves. Of particular interest is the “square-ness” of the low frequency waveforms, and whether there is any noticeable “grass” or “peaky” looking waveforms exceeding the peak level of the low frequency signals. The top of the low frequency waveforms should look very “flat.” If the top appears to “tilt” in any manner, then there is a low frequency deficiency in the STL system. (We’d offer further information here on the “how and

why” this occurs, but that could consume a whole chapter by itself!) Simply stated, the problem could be due to either AC coupling in the STL system or “bounce” generated by the modulator, demodulator, or PLL of the STL. Sometimes it’s a little of each!

If you notice any “grass” exceeding the peak level of the low frequency waveforms, there could be noise or interference getting into the system. This can occur if the RF path is noisy due to RF signal loss or if on-channel or adjacent interference is present at the receiver. Such “grass” in the form of ultrasonic overshoots can also be added to the signal if the signal path through the STL system is not linear within the composite signal bandwidth.

A simple fix for either of these two problems is to employ a composite clipper at the transmitter site. But beware: Clipping these artifacts can lead to significant audible distortion and degradation of the subcarrier region of the signal.

While the above items must be given some thought, there are many advantages to installing the processing at the studio. If the STL link is of late design and operates as designed, superior performance can be achieved, along with having easy access to the processing for monitoring and adjustment.

## Digital STL Use

If the Digital STL employs a data reduction codec (compression), we strongly recommend that the Omnia-5EX be located at the transmitter site. (See “Pre-Emphasis: Where To Insert” below.) If the Digital STL is a linear system without data compression, we still recommend placing the processor at the transmitter site. However, the Omnia-5EX can be placed at the studio if you follow a few guidelines and are willing to accept some limitations. (See “Interfacing with a Digital STL and/or Exciter” below.) In this scenario, there also must be a provision for a stereo generator/encoder at the transmitter (most digital exciters provide this function); therefore the composite clipper in the Omnia-5EX cannot be used. Many exciters include some form of safety clipper or limiter as well, but these can add distortion and unexpected overshoots if not set up properly.

## Monitoring Point

Once Omnia-5EX is on the air, you should select a good acoustical location for monitoring and adjusting it. We feel that a good tuner with strong reception feeding a good set of studio monitor speakers is probably sufficient. While car radio and other “typical listener situations” are important in judging the sound of Omnia-5EX against other stations in your market, they should not be your main reference points. In addition, there should be known-accurate modulation monitor available. If one is available, connecting an oscilloscope to the composite output of the modulation monitor will further aid in observing the overshoot performance of the system.

## Good, Clean Source Material

A well-respected processing colleague once said, “Garbage in produces more garbage out!” He was not wrong. If your source material is poor, or poorly performing playback equipment, you will not get maximum sonic benefit from your processor. Modern audio processors magnify, good or bad, whatever is present in the source material. Anomalies that you may perceive to be processing problems may in fact be source material problems that are being exaggerated by the processing. Make sure that you start out with a good first step—good source material.

## Studio Microphone Processing

This may appear trivial, but the perceived sound of “live” voices over the air can change dramatically with different microphone processing systems. There is a high probability that the sound of your on-air microphones will change when you change on-air processors. If you utilize microphone processing, you may have to readjust it to suit the operation of your new processing system. Most announcers develop a “comfort zone” with respect to how they perceive their voice on the air, especially in their headphones. When that “comfort zone” is changed or modified, a common response is that “something is wrong” with the on-air sound. Microphone processing can be a very

*Omnia-5EX Use and Operation Manual – V: 1.1*

important part of your overall station sound, but it must always work in harmony with the main on-air processing. There are many good microphone processors available, including Omnia's own ToolVox. More information on the Omnia ToolVox Microphone Processor can be found on the Omnia website at <http://www.omniaaudio.com>.

## An Important Word About Time Delay

A question commonly asked about Omnia-5EX is "How much time delay does it have?" The answer: "Not enough to drive your DJ's crazy!"

Certainly, there is reason for concern about the propagation delay through any digital transmission device, audio processors included. We have measured the propagation time delay, the amount of time it takes for the audio signal to travel from the input of Omnia-5EX to the output at approximately 9ms at 1khz. This is enough for a slight voice-character coloration to be audible to the person speaking, but usually not enough to be a problem for talent monitoring off the air. If there is additional delay added to the system, such as a Digital STL, the cumulative delay may become excessive and cause discomfort for the on-air talent. Real-world tests conducted by Jeff Goode in Indianapolis determined that a slight echo may begin to be heard at 10-15ms, and that anything above 25-30 ms is usually too annoying to talent for monitoring off-air.

## Operating Levels

Proper system audio operating levels are a must! It is important to make certain that the input and output levels of the Omnia-5EX are set appropriately. If they are set too low, you will compromise the signal to noise ratio of the system. If they are set too high, you may run out of headroom and encounter clipping on signal peaks. In addition, operating a processor with insufficient level into an STL system can cause loss of modulation and loudness. If you are comparing the Omnia-5EX with another processor, be sure they are both operating at the same levels. Your modulation monitor is an important tool in any processing comparison, and for getting the most out of your processor.

# Omnia-5EX Connections

## FM Mode (Conventional Channel) Output Connection Options

Tests have shown that post-processing audio power in the low frequency region is so strong that it may affect the performance of some exciters. It is imperative that your exciter have a dual speed PLL in the AFC, otherwise it may unlock. If one of your processing goals includes solid, powerful bass on air, this is an important key point that cannot be overlooked or loudness will be lost due to inefficient modulation.

Output choices are:

**Left/Right Analog:** This option is provided for compatibility only, and is the least-recommended choice. The DSP based digital stereo generator included in your Omnia-5EX provides superior performance, and should be used instead of the one provided in the exciter.

**Analog Composite:** If you don't object to your air chain being partially analog, this option will provide excellent peak control and sound quality. Be sure to use good quality low capacitance coaxial cables for best performance. Typical cables may be RG-58 or RG-62 type.

**AES/EBU:** Selectable sampling rates are provided to minimize overshoots caused by down-sampling in external equipment. This option, however, cannot make up for potential sonic degradations (see "Interfacing with a Digital STL and/or Exciter" below).

The typical connection to a digital STL or exciter is through the standard, balanced AES/EBU connection. Using a shielded 110 ohm digital audio cable with appropriate XLR connectors on each end, connect the processor to the exciter. Cable length should be as short as possible, and may not exceed 100 meters (328 feet). The exciter input should be set for *flat* input, which means that the exciter is not adding any pre-emphasis to the input signal. In the Omnia-5EX Input menu set the **Pre-emphasis** option to "ON" at the correct value for your country. In the Output Menu, set the **De-emphasis** option to "OFF". This ensures that output from the processor is now pre-emphasized according to the standard in use in your country. You will also need to adjust the output levels and Output Sampling Rate in the Output Menu. Since the digital exciter will be providing the stereo generator function, you must set the **Peak Output Levels** in the Output Menu for the proper AES/EBU discrete left/right channel levels, and also set the **AES-1 Sample Rate** to the actual internal operating sample rate of the exciter. For the AES-2 output, the output sample rate is set using jumpers on the internal SRC (Sample Rate Converter) board.

## Interfacing With A Digital STL and / or Exciter

At the time of this writing, many engineers are proponents of the *all-digital* broadcast transmission path. However, there are some key issues, which must be dealt with when implementing all-digital transmission in order to preserve loudness without sacrificing audio quality. One issue concerns the sampling rate of the audio processor and that of the exciter. In order for two differently sampled systems to be interfaced in the digital domain, a neat little device known as the "sample rate converter" is used.

For instance, a device which outputs digital audio data using a 48 kHz (or higher) sampling rate can be converted *down* to a lower rate of, say, 32 kHz. Unfortunately, unless spectrum is limited to the Nyquist frequency of the lower rate, overshoots can be created, robbing you of loudness. Detailed information can be found in the technical papers "Critical issues and Considerations for an All Digital Transmission Path," "Digital Dynamics Processing: It's All In The 'Samples!'" and "Digital Broadcast Audio Processing: Finally, The New Frontier" on the Omnia Tech Info web page at <http://www.omniaaudio.com>.



When using the AES/EBU outputs to drive a digital STL or exciter, your Omnia-5EX's sampling rates must be set to match the lowest internal operating sampling rate used in any device which follows the Omnia-5EX in the audio chain. You will find these options in the Output Menu; available selections are 32kHz, 44.1kHz, 48kHz, and 96kHz. Failure to select the proper digital output sampling rate can result in generation of overshoots.

## Pre-Emphasis: Where To Insert?

Most digital exciters can generate pre-emphasis within their DSP stereo generator. This is unnecessary when using an Omnia-5EX, which provides not only the proper pre-emphasis for any region in the world, but maintains excellent peak control of the pre-emphasized signal so that no overshoots occur. Using pre-emphasis in the digital exciter instead of that built into your Omnia-5EX will result in degradation of performance. Here is some background in the context of operating in a complete digital environment:

- Most exciter manufactures recommend the use of their own pre-emphasis network. If this is done, incoming audio data from the processor must be *de-emphasized* before it reaches the exciter. Why perform the emphasis function twice? Also, and more importantly, if the pre-emphasis phase delay is not **exactly the same** as the previous de-emphasis in the processor, overshoots will occur. Therefore, it is far more advantageous to employ pre-emphasis only once—in the Omnia-5EX—and set the exciter to accept a *flat* input, which greatly reduces the chance of overshoots being generated. The Omnia-5EX should always be the standard!
- We understand why the exciter manufacturers provide these pre-emphasis options; it has to do with digital codec STLs. Research has shown that pre-emphasized audio routed through a codec is not very *friendly* sounding. Hence the de-emphasis in the processor, and second pre-emphasis in the exciter. This is, in our opinion, a poor solution to the problem. If you *must* use a codec STL, locate the processor at the transmitter. Doing so completely eliminates any pre-emphasis/codec abnormalities in the processed audio, and also allows the processor to have the best possible electrical coupling to the exciter (be it analog or digital).

Hopefully this discussion has served to illuminate some of the issues involved in creating an all-digital transmission path. Should you experience any problems with overshoot or added distortion after this system is in place, you should look to the function of the digital exciter and its stereo encoder. As a reference, you can easily make signal comparisons with the analog outputs from the Omnia-5EX system, especially the composite output. Viewing the signal on an oscilloscope should reveal that the output is well controlled, with no overshoots, providing a clean baseband spectrum.

## HD Mode (Digital Channel) Output Connection Options

The Output Menu contains a virtual patch bay for assigning the Omnia's three different outputs to its two main processing chains. Note that the two Composite MPX Outputs are always connected to the conventional FM processing blocks.



- The Analog outputs (XLR's) follow the source selected, and de-emphasis is applied as selected in the Output Menu.
- The AES-1 Output follows the source selected, and at the sample rate options provided in the Output Menu.
- The AES-2 Output follows the source selected, and at the sample rates selected internally on the Sample Rate Converter PC board. See the next page for the layout of the Sample Rate Converter PC board and the location of the sample rate selection jumpers.

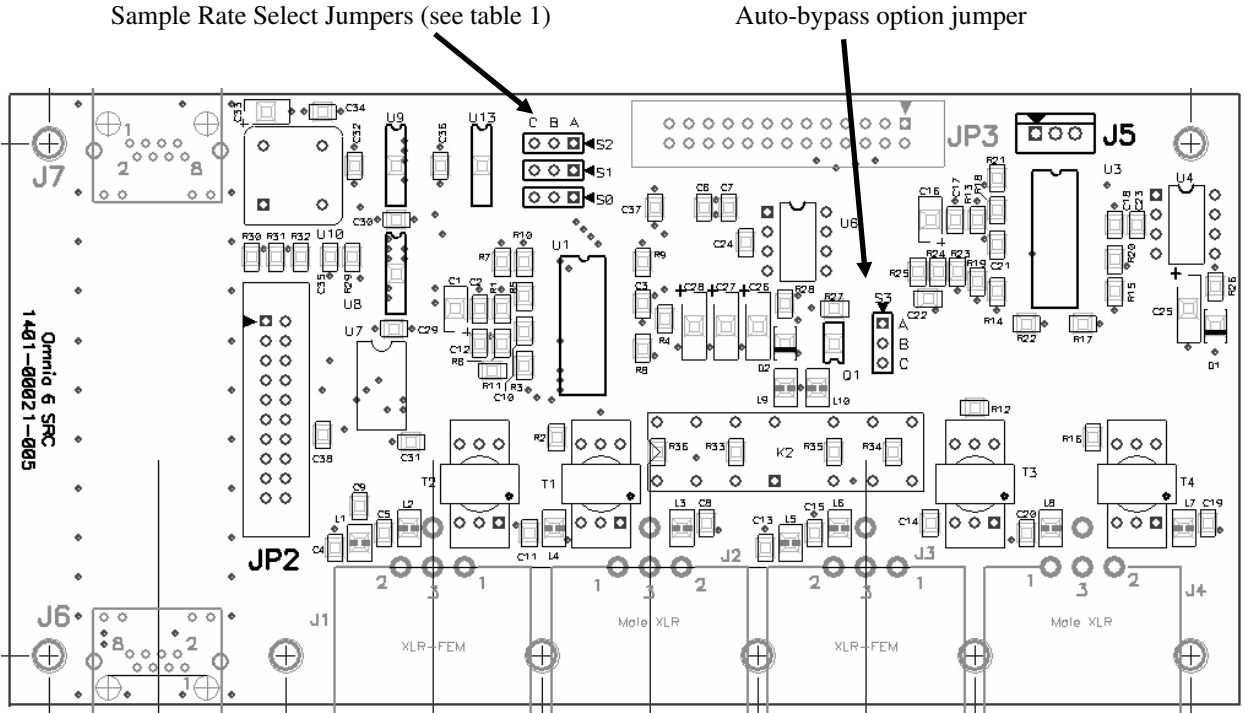

Jumper S2 causes AES-2 to either be slaved to the sample rate of AES-1 or controlled by S0 and S1.

**Table 1 - Jumper Setting Options for S0, S1 and S2**

Sample Rate	Jumper S0	Jumper S1	Jumper S2
32 KHz	B - C	B - C	B - C
44.1 KHz (DEFAULT)	B - C	A - B	B - C
48 KHz	A - B	B - C	B - C
96 KHz	A - B	A - B	B - C
AES-2 Slaved to AES-1	Don't care	Don't care	A - B

# Chapter-5: Fine Tuning Your Sound

Many broadcasters will be amazed at the dramatic sonic improvements Omnia-5EX delivers right out of the box and using one of the included factory presets. Some will want to tailor one or more of the presets slightly to create a more “custom” sound for their station. Still others will wish to really delve in and significantly modify the parameter settings to create their own unique “signature sound.”

## About Loudness and Listener Fatigue

If you're an audio processing expert, you'll find what we've included within the Omnia-5EX to be the most powerful tools ever. If you're new to audio processing, we recommend proceeding with caution and with knowledge of your goals.

Getting the most out of your Omnia-5EX processor (or any other processor for that matter) starts with knowing your objectives beforehand, and knowing where you can make tradeoffs. If your goal is to be the loudest station on the dial *and* obtain extreme amounts of detail and quality, keep in mind that there *are* limits. Reaching one goal is usually at the expense of the other. Thus far, we are not aware of any research or ratings information that proves that being the moment-to-moment loudest station on the dial is of any benefit to the listener. There will always be those individuals who feel that louder at any cost is better. The added distortion from the endless and pointless pursuit of raw loudness may generate negative effects on your listeners. Be careful.

Having said all of this, we firmly believe that Omnia-5EX will get you closer to your ideal than any other processor or combination of processors available today. It is definitely capable of generating moment-to-moment loudness; it has the *muscle*. It also maintains that famous Omnia *clarity* sought after by top programmers all over the world. We encourage broadcasters to utilize the power of the Omnia-5EX to create good, *competitive* loudness while maintaining a higher degree of quality.

## Clarify Your Processing Objectives

Whether one is seeking better overall quality or specific spectral improvements, try to articulate and write down your goals. Do you want a little more loudness or “presence” on the dial? Are there certain characteristics of the sound of other stations in your market that you like, want to emulate, or just surpass? Are there any you want to avoid? When adjusting processing, please give thought—real thought, to how you'd like your station to sound. What do we mean by that? Well, if your desire is to add loudness, and in most cases it probably will be, decide on the *degree* of loudness that you want. Is the goal to be *competitively* loud with respect to other stations on the dial, or must you be the *kingpin*, the moment-to-moment loudest thing known to God and Man? This will impact how you set up the processing.

Engineering, programming, and management should all participate in the development of these objectives. After all, processing can have a direct effect on the bottom line of your station. A little bit of agreement and cooperation on the goals before installation can save you a whole lot of disagreement afterwards.

## Set Aside Some Time

It can take some time, a good deal of serious time to optimize the audio processing for your station. We realize that in our business today, time is a precious commodity. But please don't try to install the Omnia-5EX in between other major projects or during the week your boss or your assistant is on vacation. Make certain in advance that the staff members who helped you set your objectives will be available to consult with you when you adjust the processing parameters.

How much is enough time? We feel that working with a system for at least a week is a good starting point. We don't suggest that you drop everything for a solid week. What we do recommend is that you install the Omnia-5EX during a week when you can spend a few hours per day on the project.

## The Adjustment Procedure

1. Review your objectives.
2. Once on the air, start with a degree of processing that is similar to that currently used by your station and then, if desired, become more aggressive. A careful approach is less likely to draw hasty, or even negative, opinions.
3. Listen for a while, then adjust, and listen for a while again. Try to avoid the temptation to continuously “fiddle” with adjustments, just moments after getting the system on the air. Remember that you should evaluate the operation over time, not moment to moment! When it is time to adjust, the Worksheet provided on Page 120 can assist in tracking your progress and establishing improved settings of operation unique to your stations.
4. While making changes to the system, we recommend that you do not make hasty or radical changes. Also, do not make too many different adjustments all at once. If too many parameters are changed at one time, it is hard to determine which change made the difference you may hear. That can be frustrating, whether the change made your station sound better or worse. Take your time. In order for you to become comfortable with your new sound, you should learn the limits of each control. We suggest making changes in increments of no more than +0.5 dB or - 1 dB, or in 1 or 2 step increments. Try turning different functions on and off. Working this way, you will be able to get a better feel for the sound that the Omnia-5EX is capable of producing on your station and with your programming.
5. Use the “sleep on it method:” Spend time adjusting and then listening, and when the system gets to a point where it sounds good, stop! While making changes to processing, there does come a time when the ears become less and less sensitive to the adjustments you're performing. Ears tire, and that's why spreading the adjustment period over a number of days is recommended. If what you've done still sounds good after you have “slept on it,” stop adjusting. If you're not quite there yet, continue with small iterations until you're satisfied. If you are homing in on your goals, you'll find that each day the discrepancies become smaller and you're making fewer adjustments.
6. When you get it where you like it, ***stop and enjoy!***

# The Meter Display

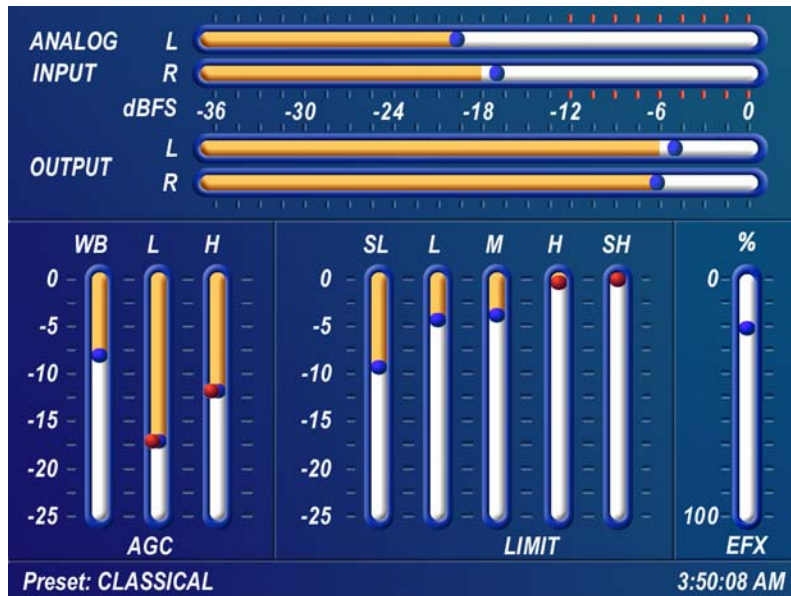

In addition to the Input and Output Levels display, the Meter Display also provides processing information in the form of vertical bargraphs, which indicate both AGC and Limiter Processing activity.



AGC Metering

Limiter Metering

Omnia-5EX Main Metering Screen

## AGC Metering

The bargraphs for the AGC sections can indicate up to 25 dB of gain reduction. When the “bouncing ball” indicators on each bargraph change to RED, the *Gate* function is active for that band.

## Limiter Metering

The bargraphs for the Limiter section provide a wealth of information about the peak control in Omnia-5EX. The limiter algorithms automatically adapt the style of peak control being employed on a moment-by-moment basis. This can be deduced if the metering is studied over time. During normal operation, the limiter indicators will have a dynamic “bounce” that you will be able to get a feel for. Every now and then, you will see the limiter react quickly and show a larger amount of gain reduction. Notice that the response is very fast. This action will recover very slowly, and return to “rest” with the main bargraph. This action will be easily noticed on material that is very dynamic in texture. It is partly due to this very special behavior that the Omnia-5EX has the musicality and clarity that other processors lack.

Another feature unique to Omnia-5EX is limiter “Hold”. During brief pauses in audio, the limiter bargraphs will “freeze” and the “bouncing ball” changes from blue to red to show the limiter has entered the *Hold* mode of the algorithm; akin to the *Gate* function in the AGCs. This is most easily noticed when there is a “dry” voice being processed. The Limiter bargraphs, like the AGC section, can indicate up to 25 dB of gain reduction.

## Interpreting the Gain Reduction Meter Displays

Through careful observation of the processing bargraphs, significant information can be acquired and analyzed about the audio signal on a moment-by-moment basis. The yellow bar shows the average value of the gain reduction, while the floating ball indicates the peak value of gain reduction.

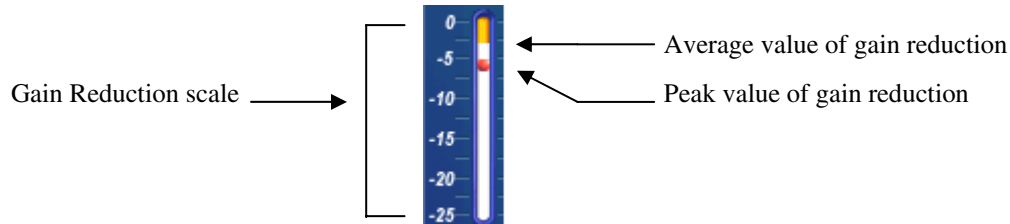

**Gain reduction meter (typical)**

Since the processing algorithms in Omnia-5EX 'adapt' to the audio, it is capable of performing many different processing functions at different times. The processing display bargraphs may appear to indicate different kinds of operation with different program material. This behavior is primarily based on dynamic range differences in the applied program material. For program material that is already processed or lacking dynamic range, the bargraphs will indicate differently than with material that possesses a high degree of dynamic range. This is because audio signals that lack dynamic range, naturally or by previous processing, will possess a lower peak to average ratio. Conversely, audio signals with a wide dynamic range possess a higher peak to average ratio. The Omnia-5EX adapts differently to each case.

For program material that has low dynamic range (or high RMS and low peak levels), there will be more activity in the AGC sections and less activity in the Limiters. This behavior is due to the AGC sections response to high RMS energy, while the Limiters are reacting to lower peak energy. Sometimes the Limiter section may not indicate any action at all, especially on the top three bands. For Omnia-5EX, this is completely normal! Examples of this behavior might be seen with heavily processed commercials or music, or with music passages of sustained level. A good example is the Aerosmith CD "Pump." This recording has very little dynamic range. Try any up-tempo selection from this disk and you will see the Wideband-AGC section make initial adjustments along with small amounts of limiting. Once adjusted, the Wideband-AGC section will stay deep in gain reduction, although with little movement, and action within the limiters will be minimal.

When the programming has wide dynamic range (low RMS and high peak levels), the opposite will occur. The Limiter section becomes active, while the AGC section will appear not to respond as much. During these events, the Limiter sections could be working aggressively, while the AGC sections indicate little activity. Good examples of programming able to cause this behavior: vocal passages, live voice, classical music, and passages with high transient levels. Good test examples: almost anything classical, as well as almost anything by Steely Dan!

Also keep in mind that the AGC sections are designed to operate much more slowly than the Limiter sections, primarily because of the nature of each function. Remember that the AGC sections operate on the program's RMS energy. During gain calculations, the incoming program's "average" level is established, and gain adjustments, if needed, are made based on those calculations. This is why the AGC sections will appear to move slower than the limiters ... they are making changes, as needed, over relatively long time periods.

The intent of the Limiter sections is to control the peak levels. This is accomplished by finding and controlling the

highest peak of the audio waveform. The Limiter section's job is to quickly grab the signal, reduce the gain to the proper operating range, and then return the gain to normal until the next peak signal comes along. Peak energy must be detected and adjusted in a quick and accurate manner while, at the same time, not interfering with the sonic integrity of the audio signal. For this reason, the Limiter sections operate very quickly, with special background instructions to govern their behavior, and strictly on an as-needed basis.

Since the processing displays are capable of providing a wide range of information, we do not recommend setting up the system based on any specified meter indications. Instead, we recommend setting up the processing by using your ears to judge the sound. We've provided the meters only to analyze the signals and aid you in adjusting the specific parameters needed to achieve your desired sonic results. Like a speedometer, the meters are a guide, not the road!

## Our Factory Presets Are Only Starting Points!

Numerous factory presets have been provided for you to use as starting points for customizing your stations' sound. A “preset” is simply a large table of values representing all of the control values for every control listed in the menu tree. When you *Choose* a preset, the control values are loaded into the DSP structure, reconfiguring the Omnia-5EX's processing.

Omnia/Telos does not warrant in any way that these presets are *de facto standards* for the format names that we used when we designed them. The factory presets were created as starting points, typical of the on-air sound that might be typical with such format names, but they are not engraved in stone! For instance, the technical sound of CHR stations usually varies from market to market, even though the overall playlist doesn't. Therefore, you should never assume that because we have a preset name that matches your format, that it is the best preset for your format in your market.

For example, if your station is running an Oldies format, you may want to start with the RocknRoll preset instead of the SolidGold preset. That's OK! Start with the preset that sounds the closest to the sound you are looking for. In some markets, our factory presets may sound too strong or aggressive. In other markets, they might not be aggressive enough. The factory presets in our previous Omnia product were judged by our customers to be about in the middle of the playing field with respect to where they needed to be to be good starting points.

Always rely on our factory presets to get you started. Then, once you find the preset that most closely matches the sound you're after, you can customize more to your liking. All Omnia-5EX's leave the factory with the same presets. They can be used as-is, or be excellent starting points for tailoring the sound of your Omnia for a specific requirement. All of the parameters belonging to a preset can be edited using the Process Menu to obtain the sound you desire. Your edited preset is then saved to the PC Card under a name you choose, and can be reselected at any time just like the factory presets. Editing presets is covered in detail in Parameter Editing below.

Always remember that when “crafting” that special sonic personality for your station, Omnia-5EX gives you the power to create a sound that can be totally different from, and far better than that of your competitors. We've enjoyed giving you that power, and we hope that you enjoy using it!

## Loading A Preset



From the *Main Menu*, highlight **Preset** and click the jog-wheel.



**Main Menu**

The Preset window is then displayed:

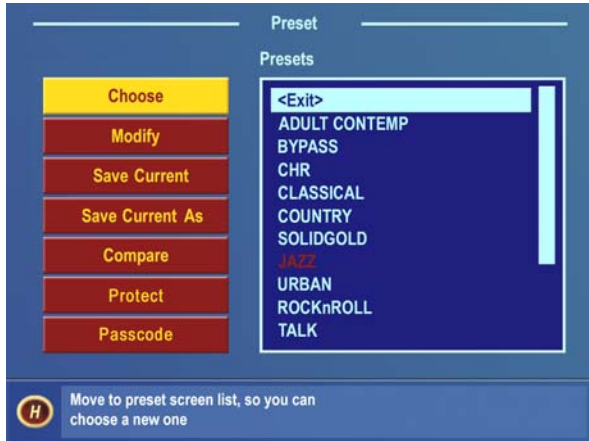

**Preset Submenu**

Rotate the jog wheel two clicks clockwise to highlight the **Choose** option. Clicking the jog-wheel once will move the highlighting to the <Exit> selection in the preset name list. Rotate the jog-wheel clockwise to scroll down the list, highlighting each preset as it goes. Once you have highlighted the desired preset name, just click once to load that preset into the Omnia-5EX. To exit the preset selection list, rotate the jog wheel counter-clockwise until the <Exit> option is highlighted. Then click once.

The name of the preset that is currently loaded is always displayed in the lower left corner of the metering display screen.

# Parameter Editing

The Omnia-5EX system architecture has a great number of audio processing functions and features. The following sections detail the adjustments one can make.

Before tackling this section you must be familiar with navigating through the menu system and be comfortable with how the Omnia-5EX jog wheel and click functions work. If so, you're ready to tackle Omnia-5EX's more sophisticated adjustments. To edit a preset it must first be loaded into the Omnia-5EX. Once loaded, it can be modified as required to suite your tastes and processing goals. The changes can then be temporarily used, or they can be saved to the PCMCIA Card so they won't be lost.

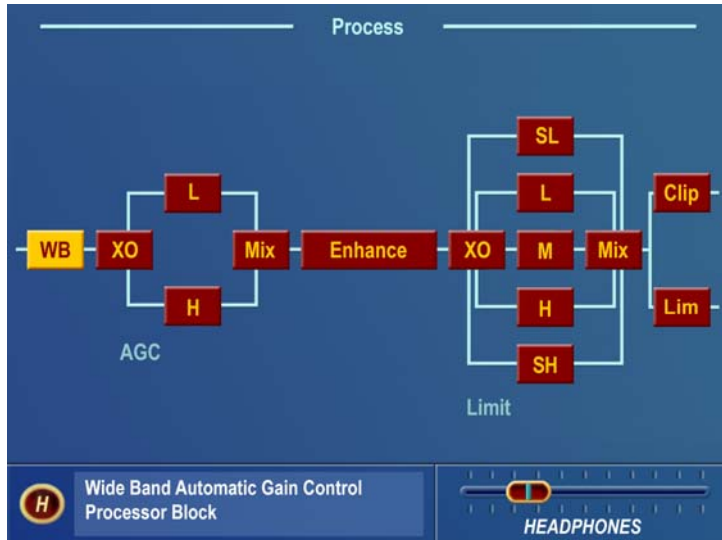

## Process Submenu

The *Process* submenu accesses the soul of Omnia-5EX. This is where comprehensive adjustments to the audio processing can be made. We suggest that if you are somewhat inexperienced with audio processing adjustments, you should use care and patience while in this section. Unlike other processors, the Omnia-5EX does not limit the range of adjustments that you can make. It is essential that you know what your goals are before and during adjustments! This section of the manual will help you do just that.

Upon selecting the Process menu, a functional block diagram of the processing system appears on screen. This block diagram not only indicates the architecture of the processing system, but also provides direct access to the adjustments for each processing section. As the jog-wheel is rotated the different processing blocks are highlighted. Clicking the jog-wheel opens up the parameter window for that processing block.

Parameter adjustment is accomplished using the previously described method—clicking the parameter to select it, turning the jog wheel to adjust it, and then clicking to save the selection and change the jog-wheel back to Highlight Mode. The following sections provide insight into each of the processing blocks and their associated adjustments.

## Wideband AGC (WB)

This is the first processing section within the Omnia, so the controls in this section affect the overall signal, its density, and hence affect every other processing section following it. The job of the Wideband AGC is to erase long-term audio level fluctuations, while doing so in a very unobtrusive manner.

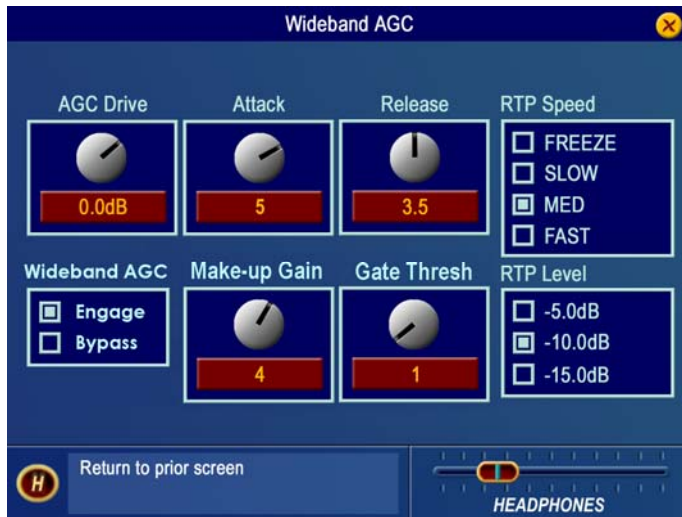

**Wideband AGC Submenu**

The **AGC Drive** control is calibrated between  $-12\text{dB}$  and  $+6\text{dB}$ , and adjusts the signal level into the Wideband AGC. This control should be adjusted to net approximately 12dB of gain reduction with typical programming. Too little gain reduction can defeat the “leveling” function of the Wideband AGC. Too much gain reduction has little additional benefit. Nominal gain reduction values for the Wideband AGC are between 10 and 15dB.

The **Attack** and **Release** controls set the Wideband AGC time constants in relative terms using the numbers 0 - 7. Lower numbers are slower time constants, while higher numbers are faster time constants. Because the time constants are program-dependent, calibrating these controls in absolute time values (ms/dB) would be useless—therefore we use relative numbers. Use a *higher* number if you want “faster” attack and release, and a *lower* number for “slower” attack and release. A special algorithm within the Wideband AGC Attack time circuit prevents the loss of Wideband AGC gain reduction when the Attack time control is operated at extremely slow values.

The **Make-Up Gain** control sets the amount of gain to be filled in during quieter, softer program passages. The range is **OFF** to 7. This function is also program dependent, and it interacts somewhat with the main Attack and Release time constants. As the attack/release times are modified, the system also scales the **Make-Up Gain** time constants. Use *less* makeup gain for processing more faithful to the source material; use *more* makeup gain for greater loudness and “density.”

The **Gate Threshold** control sets the level at which gating of the AGC occurs, “freezing” the gain during short pauses. Correct adjustment of this control helps to minimize “pumping”, and the increase of background noise during pauses in programming. The control range is **OFF** to 7.

There are two RTP (Return to Platform) parameters, **RTP Speed** and **RTP Level**, which determine what happens to the AGC gain when the **Gate Threshold** is reached and audio is gated. With the **RTP Level** set to  $-5$ ,  $-10$  or  $-15$  dB of gain reduction, the gain will return to that pre-defined level when gated. How quickly the target gain reduction level is reached, is set by the remaining **RTP Speed** settings (Slow, Medium or Fast). If no RTP gain reduction is

desired, use the *RTP Speed* setting *Freeze*.

**Note:** The *Freeze* setting will keep the gain from *decreasing* when the AGC is gated (moving *down* on the bargraph meter toward the *RTP Level* setting) but will not keep it from *increasing* toward the *RTP Level* setting when the gate activates at a gain reduction level higher than the *RTP Level* setting. For example, if the *RTP Level* is set to  $-5$  dB and the gate activates while the amount of gain reduction is 10 dB, the gain will recover to the  $-5$  dB gain reduction level before it freezes.

Note also that due to the way in which the RTP 'circuit' works, the RTP Speed settings are somewhat affected by the setting of the Attack time control.

For some presets, small changes we made to the compression ratio will affect the displayed value of the RTP. For instance, if you set the *RTP Level* value to  $-10$  but notice that the band gain recovers only to  $-5$  dB when gated, it is because we have set a slightly lower ratio. Simply use the  $-15$  setting in this case to have the gain return to  $-10$  dB when gated. Note that ratios are critical to the open and musical sound of the Omnia-5EX, and therefore we do not offer them as user adjustments.

If you wish to bypass the Wideband AGC stage, you may do so by selecting the *Bypass* option. When the AGC is bypassed, the static gain remains the same as if 12dB of gain reduction was in effect and the *Master Drive* control was set at 0.0dB.

## AGC Crossover (XO)

The audio signal from the WB AGC section is divided into two frequency bands within the AGC XO section. The crossover frequency point is fixed at 330 Hz with a 12 dB per octave slope.

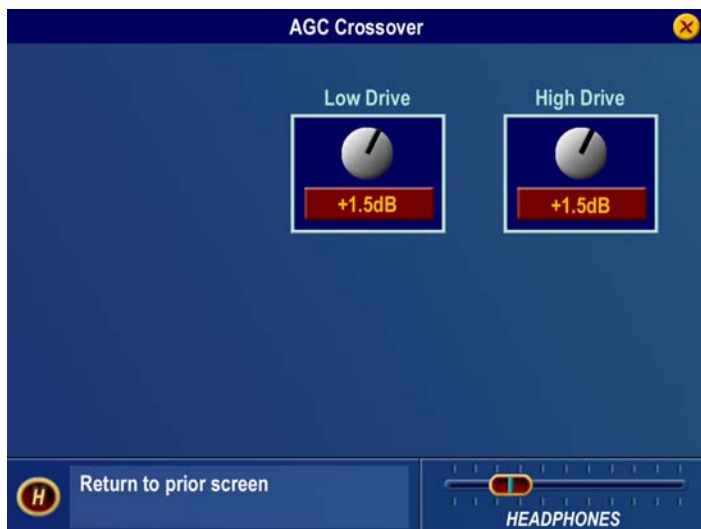

**AGC Crossover Submenu**

The drive level to each AGC band can be set by the controls at the top of the window. There is  $\pm 6$  dB of gain adjustment available for each band. Just as in properly setting a program equalizer, the best sound, consistent with preserving signal headroom is usually obtained by reducing the gain of the louder band(s) rather than increasing the gain of the lower level band(s).

For example: if the program source material has widely varying high frequency levels, a common action is to just turn up the output mixer controls. However, consistency can be improved much more effectively by adding a bit more drive level to the upper AGC bands, and then reducing their output levels slightly in the post AGC Mixer. This type of adjustment strategy will result in better long-term high frequency consistency, and a more pleasing air sound.

## Two-Band AGC Windows

Each of the two-band AGC's has its own set of controls similar to those in the Wideband AGC section. The four controls in these windows, *Attack*, *Release*, *Make-Up Gain* and *Gate Threshold*, and the two parameter selections, *RTP Speed* and *RTP Level*, function like those in the Wideband AGC window. Adjustment strategies are similar, however in the mutiband AGC sections adjustments are on a “per-frequency band” basis.



**Low Band AGC shown – the other band is identical**

As with any multiband processor, improper adjustment can exaggerate noise at high frequencies, particularly with older recordings that possess a good deal of tape hiss. This can especially occur if the higher AGC bands are driven so that significant gain reduction occurs, and the band's gating control is set to the lower end of the scale. During audio segments that have little or no HF content, the AGC will try to increase its gain in an effort to restore treble balance. Even during periods when the gate function is in the default *Freeze* mode, the problem might still exist with some programming. In those situations, even an increase of the gate threshold control to higher numbers may not help the situation.

Therefore, both bands of the two-band AGC incorporate a Return To Platform (RTP) feature similar to that available within the Wideband AGC process block. When the RTP function is set to a value other than *Freeze*, the band gain will be forced to recover its gain to a static value lower (less gain = more gain reduction) than might be achieved if the control was set to *Freeze*. The RTP levels can be tailored for each band as desired.

Use the *RTP Speed* to set the amount of time it will take the AGC to return to the set platform level. There are four choices: *Freeze*, *Slow*, *Med*, and *Fast*. The default setting is *Freeze*. As mentioned previously, the RTP speed is slightly affected by the value of the attack time that is set for that band. The opposite is not true: *RTP Speed* does not affect the operation of the attack/release functions.

**Note:** The *Freeze* setting will keep the gain from *decreasing* when the band is gated (moving *down* on the bargraph meter toward the *RTP Level* setting) but will not keep it from *increasing* toward the *RTP Level* setting when the gate activates at a gain reduction level higher than the *RTP Level* setting. For example, if the *RTP Level* is set to  $-5$  dB and the gate activates while the amount of gain reduction is 10 dB, the gain will recover to the  $-5$  dB gain reduction level before it freezes.

Use *RTP Level* to set the platform level. There are three choices: -5dB, -10dB and -15dB.

**Note:** For some presets, small changes we made to the compression ratios will affect the displayed value of the RTP. For instance, if you set the RTP gain value to “-10” but notice that the band gain recovers only to -5 dB when gated, it is because we have set a slightly lower ratio for that band. Simply use the “-15” setting in this case to have the gain return to about -10 dB when gated. Note that ratios are critical to the open and musical sound of the Omnia-5EX, and therefore we do not offer them as user adjustments.

## AGC Mixer (Mix)

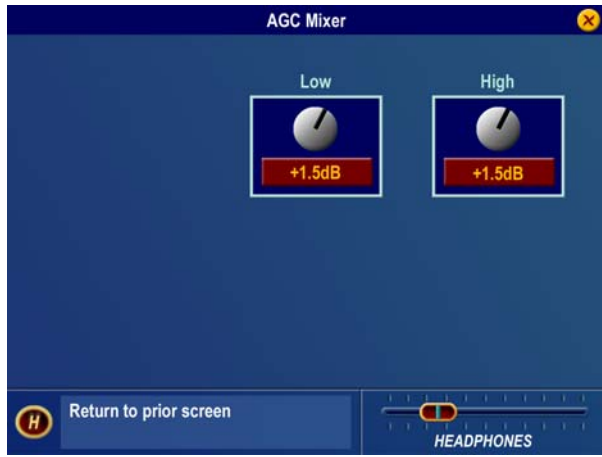

This is where the output of the two AGC's are mixed together. Use care in adjusting this section, as too much level from one band may cause an excessive amount of emphasis to that range of frequencies. This may also drive the limiter bands in that range of frequencies too hard, causing the sound to become unnatural, dense, and squashed. If your desire is to “EQ” the sound, you should perform that function using the drive levels in the AGC or Limiter *XO* Parameter Windows. The AGC mixer is primarily intended for minor “EQ” changes to the overall sound.

AGC Mixer Submenu

## Enhance



Each of the *Deep Bass*, *Phat Bass* and *Warmth* controls can boost the level up to 12 dB. Be careful here not to overdrive the following limiter sections or over emphasize these lower frequency ranges. When used properly this specialized low frequency enhancement tools can deliver the thunderous bass and warmth that the Omnia is known for, and it can do so without making the sound muddy. It serves to greatly complement the Omnia-5EX's clear and open high end to provide a well-balanced, competitive, CD-like sound that is both powerful on the dial, as well as pleasing to listen to.

Enhance Submenu

**Deep Bass EQ:** For those who demand *thunderous* bass, the Omnia-5EX has it! Up to 12 dB of “thunder” can be added to shake your listener’s walls! This is not a simple bass boost, but a rather sophisticated concept that takes into consideration the time alignment of the low frequencies as they pass through the entire Omnia system. It allows a loud, clean low end, with absolutely no sacrifice to the overall loudness of your signal. We won’t tell you where the control is in the signal chain. But we *will* tell you that **Deep Bass** function is a shelf boost at 85 Hz, utilizing a phase compensated 12dB/octave slope to emulate the EQ function.

**Phat Bass EQ:** Phat Bass is a unique enhancement that adds filtered harmonics of the lower registers to the upper bass frequencies. The algorithm extracts information contained in the initial attack to do its work, and low frequency texture is therefore emphasized. Older recordings sound fuller (or phatter) with the added illusion of loudness. **Phat Bass EQ** also helps radios with small speakers sound like they have more bass than they actually do.

**Phat Tune:** This new control brings out a previously hidden function that sets the frequency range that **Phat Bass** will enhance. A control setting of 13 corresponds to the previous software versions internal setting. Higher numbered settings will exclude more of the upper bass region from containing bass harmonics and can create a very solar-plexus type effect. Lower numbered settings will allow the bass harmonics to extend further into the upper bass region.

**Note:** **Phat** settings should be set by ear. Care should be used when adjusting these as they offer a lot of power to the bass region. Listen to a wide range of program content while setting these parameters. We do not recommend setting these to your favorite *thump* record and think you’re done. Be careful!!!

**Warmth EQ:** The Warm Bass parameter in the Enhance section of the Process submenu is a shelf boost at 150 Hz. **Warmth EQ** compensates for program material that is naturally lacking in upper-bass punch. Be judicious about applying too much, as the resonant frequency of most automobile interiors lies in this frequency range!

**Space EFX (Optional):** The Omnia-5EX contains an intelligent DSP-based stereo enhancement tool that enhances the stereo sound field without causing unnatural “hole in the middle” imaging or exaggerated multipath. Program audio previously lacking in stereo width will have noticeably increased ambiance and dimension when the **Space EFX** is active. Vocals will stay up-front and the sonic details of musical instruments are heard with an apparent slight loudness +increase when listening in stereo.

The **Space EFX** control has a range of 0 (*off*) to 16 and the amount of dynamic width expansion can be observed on the rightmost vertical bargraph on the Meter Display screen. The system should be initially auditioned using light amounts of **Space EFX**, with an initial setting of 4 to 6 recommended as a starting point. The overall stereo sound field will appear wider and be much more consistent sounding between program sources. The smart Stereo EXP algorithm turns off when a mono program source is present. If you find that your mono programming sounds a bit thin, you can add a small amount (2 dB) of **Phat Bass** boost to restore warmth to the overall air sound.



## Limiters Crossover (XO)

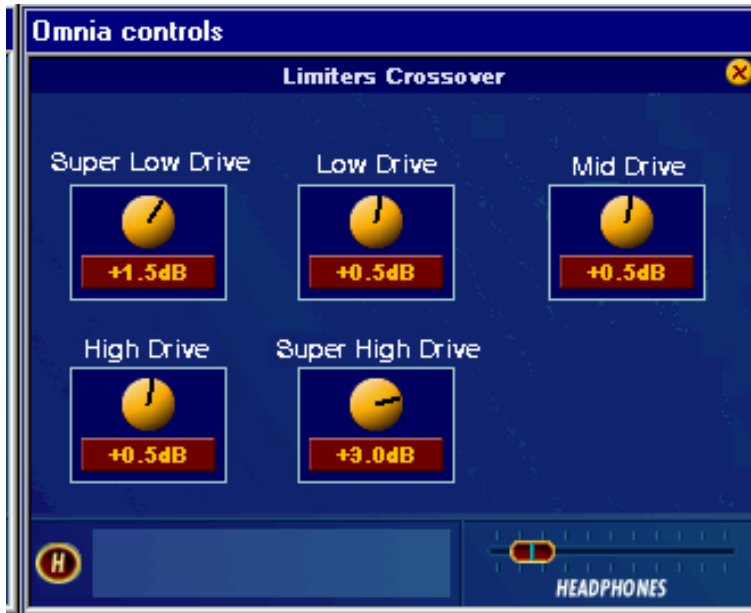

The audio signal from the Enhance section is again split into five bands to drive the multiband limiter section. The limiter crossover frequencies are fixed at 120, 480, 1600 and 6200 Hz. Factory drive settings are initially recommended, but the overall density can be adjusted by changing all five of the limiter drive controls up or down an equal amount. More drive to the limiters will increase the density of the audio providing a louder but more squashed sound. Less drive will reduce the density and provide a more open, more dynamic sound. Reducing the overall limiter drive too much can rob you of loudness.

### Limiters Crossover (XO)

Note also that the upper two limiter bands (4 & 5) will generally not show as much average gain reduction (little or none at times) as the lower three bands. This is normal and accounts partially for the improved clarity in the Omnia-5EX. You will notice brief, fast bursts of significant gain reduction on these bands especially on bright dynamic program material and vocal sibilants.

If you are familiar with the limiter section in the Omnia Classic, you'll remember that significant gain reduction was necessary in order to achieve extreme loudness. That is NOT the case with Omnia-5EX! The limiters are true limiters, and therefore don't need to do much work after the multiband AGC section to create a huge signal on the dial. In fact, the most common mistake that our first customers made when adjusting the Omnia-5EX was overdriving the limiters. A little goes a long way. In fact, it may help to think of them not as limiters, but as "Clipper Resource Allocators". They should only do just enough work to keep the audio in each frequency band from driving the final clippers too hard, and no more.



## Multiband Limiter Windows



### Limiter Submenu – SL Limiter shown as example

The controls in these adjustment windows are similar in function to the previously described AGC stages. However, there are only four controls for the limiters. The Attack and Release controls work similarly to the AGC sections, but are of course much faster on overall action. There are also two new parameters as well. The first is the **Hold Threshold**. This control sets the threshold where the limiter's *Hold* algorithm begins when it detects pauses in the audio. When it's in the **OFF** position, the limiters will attack, and then release completely, just as you would expect them to. With **Hold Threshold** enabled, the limiters will momentarily stop and rest during very short pauses, especially during live speech. Functionally, this is similar to how the **Gate** function works in the preceding AGCs. The other control is **Limit Threshold**. This control sets the threshold where audio peak limiting begins. Care is needed when adjusting this control because *raising* the threshold (counter-clockwise) causes less limiting to occur, and the resulting uncontrolled peak energy will go to the clipper instead. Thus, with this control you can artistically trade off the dynamic limiting against brick wall clipping, as each has its own "sound."

As the limiter threshold is lowered by turning the Limit Thresh clockwise, the peak output level of the limiter is reduced. The signal in that band won't hit the clipper as hard, and you'll notice more action on the limiter bargraph for that band. In fact, instead of reducing the output of one of the audio bands in the Final Mixer section, you could instead "dynamically reduce" the level in that band, which also increases density in that band) by lowering the limiter threshold.

When adjustments are made to limiter thresholds, start by making adjustments in 0.5dB steps. Reducing the threshold too much can cause the system to create an effect that "sucks out" the frequencies in that band. Conversely, the opposite (raising the threshold) will create an exaggerated effect by over-enhancing certain frequency ranges, as well as causing increased distortion, since excessive levels from that band will reach the following clipper stage. Usually, the limiter thresholds are adjusted as a "fine polish" on the final sound. If you are unsure about how to use the **Limiter Thresholds**, then we recommend that they be left at their well-researched factory settings.

## Final Mixer (Mix)



**Limiters Mixer (final mixer)**

This is the final summing point for each of the multiband limiter sections before the signal reaches the final clipper (FM Mode) or Look Ahead limiter (HD Mode). Care should be used when adjusting this section, as too much level from any particular band could cause an excessive amount of clipping distortion or Look Ahead limiting to that range of frequencies. Adjusting all five controls an equal amount is virtually the same as adjusting the *Clipper Drive* control in the Clippers window or *Limiter Drive* control in the Look Ahead Limiter window. If your desire is to provide some custom “EQ” to the sound, it is better to perform that function using the drive levels in the *AGC or Limiter X-Over* menus instead of the limiter mixer controls. Like the limiter threshold controls, the final limiter mixer is mainly for minor “fine polish” to the overall sound. Adjustments in this section must be done with care.

## Clippers (Clip) (FM Mode Only)



### Clipper Submenu

**Bass Clip Threshold:** Limiter bands 1 & 2 have their own clipper and time-aligned low-pass filter in order to reduce IM distortion in the main clipper. The **Bass Clip Threshold** control sets the threshold of the bass clipper referred to the clip level of the main clipper. A higher threshold (counter-clockwise) will reduce the amount of bass clipped by the bass clipper but cause a corresponding increase in the amount of bass clipped by the main clipper. Conversely, a lower threshold (clockwise) will reduce the amount of bass sent to the main clipper but increase the amount of activity in the bass clipper. Too much clipping by the bass clipper can soften bass 'punch'. It may also be heard as a “rattling” sound in the bass. Fine tuning of the bass clipper drive level is also possible by adjusting the band 1&2 controls in the **Final Mixer** as these feed the input of the bass clipper.

**Bass Clip Tune:** This new control sets the corner frequency of the specialized low pass filter that serves to control the introduction of Bass Clipper harmonics. Higher numbered settings add more filtering, reducing IM distortion caused by the main clipper acting on excess Bass Clipper harmonics. A setting of 0 effectively removes the filter and a setting of 20 sets the corner frequency to 380 Hz.

**Clipper Style:** This is another new function designed to alter the *texture* of the **Bass Clipper** system. These buttons select one of two specialized algorithms that control the Bass Clipper: **Tight** and **Girth**. The desired sound will determine which is better suited. **Tight:** is the established Bass Clipper system that Omnia processors have always employed. It's a straightforward hard limiter that will create a deep, sub-harmonic effect to the audio. The drawback is that it can generate IMD products within the main clipper system. **Girth:** is designed to create a *phatter* effect to low frequencies, and it will help create the illusion of more bass on smaller speakers. Also, this algorithm, which is mathematically derived, will contribute lower midrange IMD components to the spectrum. So live voice, vocals and solo instruments that are present along with strong bass in the program material will sound cleaner yet will still create an *in-your-face* effect to the low end. The action of either of these can be further tailored using the **Bass Clip Tune** that was previously explained.

**Clipper Drive:** Here is where the Omnia-5EX's loudness versus quality advantage is most evident! The main clipper is a very powerful algorithm, is highly over-sampled, and is fully anti-aliased. This clipper control's adjustment range is +/-6 dB, in 0.1dB steps. It is advisable to make minor changes, primarily as the 'loudness fine tuner'. Be careful; there is a lot of available power here!

**Clipper Silk:** This control adjusts the texture of the main clipper when the clipper is handling significant mid and upper midrange program material such as solo electric guitar, etc. We've brought out a hidden control from the distortion-canceling algorithm to allow you to make subtle tradeoffs in how the final clipper texture sounds. Higher numbered settings (clockwise) soften (or silken) the sound of the clipping at higher frequencies, with only a slight reduction in brightness on some material. The sound of clipping low frequency material (<2Khz) is largely unaffected.

**Composite Drive:** This controls the drive to the DSP-based composite clipper. A setting of 0.0 is the same as the clipper being "off". This clipper operates on the entire baseband signal up to 53kHz, except for the 19kHz pilot. No matter how hard you drive the composite clipper, you cannot clip the stereo pilot. Embedded within the composite clipper is a 53Khz phase linear low pass filter for SCA protection, as well as a wide and deep pilot notch filter. These filters combine to remove clipping harmonics and prevent them from affecting the stereo pilot and SCA regions.

## Look Ahead Limiter (HD Mode Only)



### Look Ahead Limiter Submenu

Omnia-5EX employs a Look Ahead limiter to provide absolute precision peak control for the HD Digital Channel. This limiter has been designed to minimize processing side-affects like IMD, which are usually associated with limiters of this type. Using an innovative design that cancels intermodulation products before they develop allows this limiter to sound extremely transparent. The limiting function is derived using numerous control signals that monitor one another. Customer access is provided to these signals so that the *texture* of the sound of this limiter can be altered to taste. (These parameters will be described soon!)

This type of peak controller is used instead of a clipper because it does not generate the same high levels of THD as a Clipper does. THD causes added difficulties in a coded audio system because the harmonics generated from the clipping action create added artifacts and workload in the encoder. These are especially annoying at high frequencies.

On the other hand, while a Look Ahead limiter yields extremely low levels of THD, it will create some IMD component, but this still allows the audio coder to operate with minimal sonic artifacts.

There are tradeoffs in how each of these peak controllers sound when they are set to produce added loudness. When a clipper is pushed, the audio may appear *edgier*. This is from the added harmonic content. In contrast, the Look Ahead limiter will appear *busier*, or dense as the action of the control signal may be heard, when more limiting is applied.

**Limiter Drive:** Here is where the loudness versus quality is most evident! This limiter's adjustment range is +/-6 dB, in 0.1dB steps. It is advisable to make minor changes, primarily as the 'loudness fine tuner'. Be careful; there is a lot of available power here!

**Silk Action:** This control adjusts the texture of the limiter when it is handling significant mid and upper midrange program material. Higher numbered settings (clockwise) soften (or silken) the sound of the limiting at higher frequencies, with only a slight reduction in brightness on some material but can result in a “queasy” quasi-pumping sound on some material. The sound of limiting low frequency material (<2Khz) is largely unaffected.

**Speed:** This control adjusts the speed of the peak control network, affecting the texture of the limited audio. Higher numbered settings are faster and while louder, may create a busier sound with more intermodulation distortion.

**Density:** Within the limiter algorithm are multiple networks that perform the timing, or attack/release functions. Density is a single parameter that modifies these networks with the goal of creating added perceived loudness. This feature allows the timing networks to be altered, for more/less processing, but also maintaining a balance of the IMD reducing functions. Higher numbered settings increase loudness at the expense of distortion.

**HF Shelf EQ:** Depending upon how the processing is set for the conventional FM signal, there may be a need to add or remove some high frequency spectra to the final mix if there is a desire to more closely match the sound of the Look Ahead limiter to the pre-emphasized *effect* that the conventional FM channel processing possesses. It is recommended that this parameter be left at 0.0dB to start with, and only adjusted after careful comparison to the conventional channel.

**Bandlimiting:** Omnia-5EX.HDFM is capable of delivering 20kHz audio response to the HD Radio/DAB encoder. If there is a desire to reduce the audio bandwidth, it is possible to reduce the spectrum in 2kHz increments from 20kHz down to 12kHz. All of the filters employed for this function are phase linear.

# Saving, Renaming, Deleting and Protecting Presets

## Saving Presets

Upon completing a preset editing session, the processing changes should be stored. This way they can be recalled later, or even transferred to another Omnia-5EX. Storing the settings writes them to the PCMCIA memory Card, either by overwriting an existing preset, or by creating a new preset. It is also possible to delete presets that are no longer needed, and deleting unused presets frees up memory space and makes it available for saving newer ones. The Omnia-5EX PC Card has the capacity to store up to 50 total presets. This means there is room for 25 User Presets in addition to the 25 permanent Factory Presets.

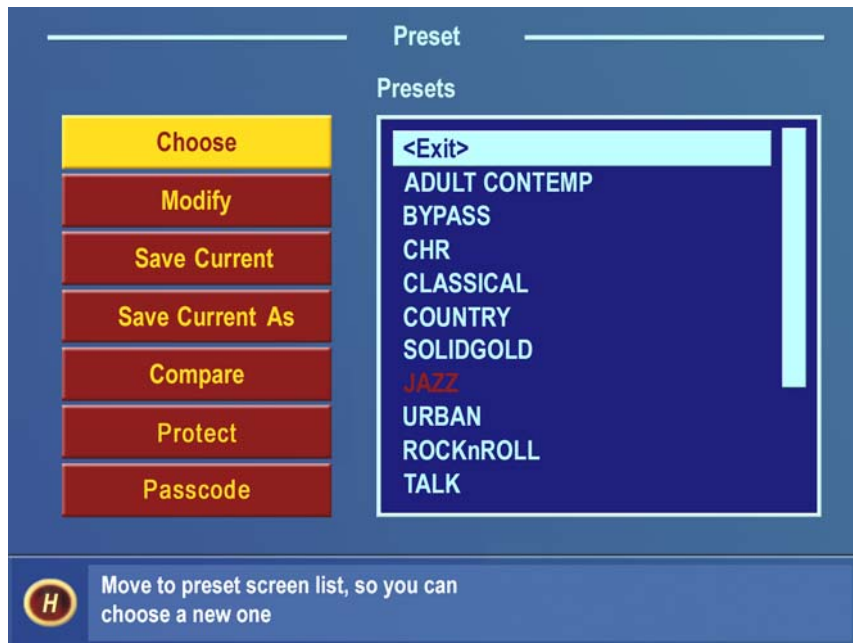

### Preset Submenu with Save options

When processing adjustments are completed, a choice should be made to either save the changes over the existing preset (if it's not a factory preset) or create a new User Preset. This is done from the **Preset** menu. If you want to save the changes using the current preset name, highlight **Save Current** and click. After prompting you to verify that you wish to save the settings over the currently selected preset, the system will save the latest changes made to the current preset name.

To save the preset under a new name, thus keeping the original preset and creating a **new** preset that will be added to the bottom of the preset list, highlight **Save Current As** and click. A “Save Preset As” dialog box appears on screen so the characters in the new user preset name can be entered. Preset names can be up to 12 characters in length.

The first character in the current preset name will be highlighted and flashing. To change this character, click the jog-wheel. This stops the cursor from flashing, indicating that the character may now be changed. Rotate the jog-wheel to step through the available characters. With the desired character shown, click the jog-wheel to select that character. This jumps the flashing highlight to the next character position in the name. If the next character does not need to be changed, rotate the jog-wheel and the flashing highlight will step past each character in the name.

After entering the preset name's last character, rotate the jog-wheel until the • **Checkmark** is highlighted. Click the

jog-wheel to save the new preset. If you wish to cancel the operation, highlight the **X** instead and click the jog-wheel. The operation is canceled and the *Preset* list and menu is again displayed.

**Note:** You cannot save a preset using any of the factory-supplied preset names. A different preset name *must* be used, using the *Save As* menu option. The factory presets are read only, and cannot be overwritten. Likewise new user presets cannot be stored with the same name as a factory preset.

## Renaming and Deleting Presets

To rename or delete a preset, highlight and click the **Modify** choice in the Preset menu. Rotate the jog wheel to highlight the **Preset List** and click. Now highlight and Click to select the preset to be modified. To rename the selected preset, highlight and click on **Rename**. The Rename Preset dialog will appear and a new name for it can be entered. (See Saving Presets above) After entering the preset name's last character, rotate the jog-wheel until the • **Checkmark** is highlighted. Click the jog wheel to save the new preset. If you wish to cancel the operation, highlight the **X** and click. The operation will be canceled and the Preset Menu again displayed. To delete the selected preset, highlight and click on **Delete**. You will be asked to confirm the destruction of the selected preset. Highlight and click on **Yes** to go ahead and delete the preset or **No** to cancel and return to the Rename and Delete screen.

## Protecting Presets

Beginning with Front Panel Display software Version 1.0.3.x, it is now possible to protect customer presets with a secret passcode. To use the feature, you must create a custom preset (or recall factory and rename it as your own). The correct order for using the Protect Preset function is as follows:

1. Create a preset and save it as your own (let's use a preset name "TEST33" as an example);
2. Click the "Protect" button in the Preset menu.
3. Enter your passcode (up to six characters), and click on the checkmark to save it.
4. The preset will now be displayed on the screen with a [U] next to it, that is, it will be shown as TEST33[U]. This means that the preset has a passcode assigned to it, but the preset is not yet "locked".
5. To Lock the preset, go back to the Preset List, click on the "Protect" button, but DO NOT enter a passcode this time – instead just click the Checkmark box. An error message will pop up saying "ERROR: Permission Denied" – this is normal behavior. Click the "OK" box, and notice that the preset is now listed on the Meter Screen as TEST33[L]. The "L" next to the preset means that it is Locked and your preset is now secure.
6. Please see the next section for how to access a protected preset.

## Passcode

In order to gain access to a preset that has been protected using the “Protect Preset” utility, the correct passcode for the preset being accessed must be entered into the prompt. Please understand that it is impossible for the factory (or anyone else for that matter) to gain access to an Omnia preset that has been encrypted by the Protect Preset utility. Unless the correct key is known (and there is only one), there is no way to recover the preset and its settings!

To access a protected preset for viewing or editing, do the following:

1. Navigate to the Preset Menu;
2. Click on the “Passcode” button.
3. Enter the correct passcode for the preset, noting that the code is case sensitive!
4. The message “sending passcode “XX” should appear. If the code was correct, the preset should display with the [U] (unlocked) symbol next to it.

- OR -

1. Navigate to the Process Menu and click on it;
2. Enter the correct passcode for the preset when prompted for it, noting that the code is case sensitive!
3. The message “sending passcode “XX” should appear. If the code was correct, the preset should display with the [U] (unlocked) symbol next to it and the Process Menu should be accessible.

Additional notes:

- a. If the preset is protected and the user clicks on the Process menu, they will be prompted for the correct passcode for the preset they wish to edit or view.
- b. Protected presets may not be viewed, edited, or printed with the remote control program unless the preset is unlocked [U] first. However, protected presets can be selected and loaded into the Omnia’s memory at any time.
- c. If more than one preset shares the same passcode, when that passcode is entered at the prompt ALL user presets protected with that passcode will be simultaneously unlocked for editing or viewing.
- d. Preset passcodes can never be deleted or changed. In other words, once a passcode has been associated with a preset, that preset and passcode are forever interdependent.
- e. You may share protected presets among other Omnia users, but the preset is not viewable without the passcode. This means that any protected preset may be loaded into any Omnia-5EX, but its contents (control settings) may not be accessed without the proper passcode.
- f. There is no back door, no secret passcode, and no hidden command that the factory can use to retrieve a preset that is accidentally locked by the end user. Presets that are locked with the Protect Preset function are encrypted using the passcode as the encryption key. Without the appropriate decryption key, the preset and its settings can never be recovered!



## Getting the Sound You Want

If you believe that you're in a loudness war and you need to react aggressively, here are some suggestions that should help you achieve that goal. Conversely, if you have the rare luxury to strive for increased sound quality, we have suggestions for you too! Omnia-5EX is designed to minimize the impact of the quality vs. loudness trade-off.

We recommend that before starting the process of *cranking it up* just for the sake of raw loudness, try to decide what sonic characteristics you feel are lacking in your station's sound. In many instances, it's not just about increasing the drive to the limiters, the clipper, or the composite clipper. It can be as simple as creating an *illusion* of added loudness by changing a single time-constant parameter. There are even known instances where the use of *stereo enhancement* created the necessary apparent loudness. Please don't bite at the first temptation to *crank* the system. Sometimes the old adage of *less is more* really applies!

Before delving into alternative processing possibilities, please give the next brief section some thought. It may help provide you with some needed direction in your overall processing plan.

### A Word about Loudness

Making this confession is a little like telling your parents you dented the car. But here it goes: It's OK for your station to be loud. *Very, very loud.*

In the past, loudness was a problem due to the limitations of the processors of the day. In the quest for ultimate loudness, you probably either adjusted (or modified) your old processor well outside of its "safe" range, or used multiple boxes in the signal chain and accepted the byproducts of the interactions and conflicts among them.

Omnia-5EX has changed all of that! It's been designed to look at the incoming audio, and *know* how to make your station consistently loud on the dial, and without the artifacts or grunge created by your current processor. Omnia-5EX makes loudness an effortless exercise for *all* formats.

One more confession. It's also OK for your station to *not* sound loud, yet sound incredibly musical and grunge-free, because the Omnia-5EX has given you the choice. Omnia-5EX is a system that maximizes the audio quality of your signal, yet at the same time satisfies your competitive requirements.

### Quality versus Loudness

The trade-off between quality and loudness is primarily determined by how you choose to use the limiting and clipping sections. While each function alone will generate "dial presence," they each have different advantages, as well as side effects.

When excessive limiting is used, intermodulation distortion is increased, making the audio sound "mushy", and "smeared." The added short-term density can also cause the audio to be "tight", "squashed", or "dense." The "dynamics" artifacts caused by excessive limiting might sound like "pumping," "breathing." The rule for limiting is "a little goes a long way!"

When excessive clipping is used, harmonic distortion is increased. The audio level is in effect "running into the brick wall." Too much clipping can cause the audio to sound "broken-up," "torn," "rough," or "edgy." As might be expected, the harder the limiters and clippers are driven, the louder the perceived audio. However, you are also much more likely to encounter increased intermodulation and/or harmonic distortion.

The following sections are provided to assist you in designing the personality of your station's sound. As we said earlier, there is no precise recipe for setting up audio processing. While there are some basic fundamentals that you can use to get started toward the sound that you desire, it may require a concerted effort with extended listening and subtle processing changes over time to achieve your ultimate goal. Just remember to know your competition, know your goals, take your time, and adjust methodically.

## Increasing Loudness

Try to resist the temptation to just *crank up* the aggressive processing sections, like the limiters. Those will add loudness of course, but usually at the cost of quality. Many times, building a little more RMS level in the AGC sections will do the trick instead, and with no obvious sonic penalties. The following are some suggestions on where to begin to make changes. We suggest that you them in the order described.

Increasing loudness can be accomplished in four ways:

1. Alter the following parameters in the AGC sections:
  - Increase the **AGC Drive** to the **WB** (wideband) AGC section.
  - Increase the **Drive** to each band of the Two-Band AGC in the AGC **XO** (crossover) screen **or** reduce (set to lower numbers) the **attack time** of the **WB** AGC section, causing an increase in activity in the Two-Band AGC sections.
  - Increase the **Release** time settings in each band to make it operate faster.
  - Increase the amount of **Make-Up Gain** in each band.
2. Modify the Multiband Limiter sections:
  - Increase the **Drive** to each section using the controls in the Limiter XO screen.
  - Increase the **Release** time settings in each band so that they operate faster.
  - Set the **Hold** threshold to a lower value or turn them off.
3. Drive the Clipper/Look Ahead Limiter sections harder.
4. A combination of the above steps, but in small increments! It might sound crazy, but it's true! In this situation, resist the temptation to make too many changes at once. When that occurs, it becomes difficult to determine why the result of an adjustment did or did not make sense. Focus on one specific area of your sound at a time. Once that area is satisfactory, then move the focus to the next area, as needed.

Based upon the above suggestions, you can experiment with different styles of processing. Some broadcasters prefer to have their processing be perceptibly loud, but dynamic. They may not have the loudest station on the dial, but the station's audio still gives the illusion of loudness, retaining detail and clarity, and while reducing listener fatigue. This can be done by centering your efforts in the Limiter sections, and avoiding heavy use of the clipper. One trick that works well is to use very fast attack and release times in the multiband limiters, but do not let them produce more than 5 dB - 7 dB of gain reduction. This keeps the IM distortion of the limiters to a minimum, and doesn't "over-squash" your sound. Adjusted in this manner, the Limiter sections are relied upon to generate higher short-term RMS levels, which translates into increases in perceived loudness.

If the quest is to produce the “loud and proud” appearance of the “big boys” in town, then the limiters and clippers should both be leaned upon a bit more. *Loudness at all costs* is usually the reason for moving the processing in a direction like this. Using larger amounts of drive to the multiband limiters, along with faster release times will generate a signal of high short-term density. Also, an increase in clipping will further aid this. The effect of the processing set in this manner is that the audio is consistently loud at all times . . . a wall of sound. The drawback is that the *density* can cause listener fatigue and have a negative effect on time spent listening. While Omnia-5EX is designed to minimize listener fatigue, it is capable of generating large amounts of density that could eventually lead to fatigue. Be careful!

## Adding More Detail — When Loudness Isn’t the Last Word

Now that we’ve “squashed the grape,” lets look at what it takes to undo a heavily processed signal. Basically, just reversing the procedures listed above will do the trick:

1. Reduce the drive to the Clipper/Look Ahead Limiter.
2. Back off on the influence of the Limiter stages:
  - Reduce the amount of **Drive** to each band in the Limiter XO screen.
  - Reduce the **Release** times to slow down recovery.
  - Raise the threshold of the **Hold** function.
3. Ease up on the Wideband-AGC sections:
  - Reduce the **Drive** to the WB AGC and the Multiband AGC bands in the WB and AGC XO screens.
  - Reduce the **Release** times to operate slower.
  - Reduce the amount of **Make-Up Gain**.

Backing off the clipping sections first will allow the processing to retain a level of competitive loudness while enhancing quality, and the overall dynamic texture will be affected less. Start with reducing the **Clipper** amount in 0.5 dB steps. It’s surprising how much detail can be restored from just a small change of 0.5 dB. Generally, changes in the **Clipper** drives will have the most noticeable effect on quality, but it will also affect the relative loudness level, too. You’ll need to find a “happy medium” that’s right for you.

## Air-Sound Equalization Changes

Tailoring the shape of the overall audio spectrum can be done in three different sections:

1. The relative **drive** settings in the multiband AGC **XO** menu. These controls set the drive levels of the multiband AGC sections.
2. The relative **drive** settings in the multiband Limiter **XO** menu. These controls set the drive levels of the multiband limiters.
3. The settings of the multiband limiter **Mixer** controls.

All three options will provide noticeable change in EQ. We suggest you use the first two listed options. In either case, an EQ change is still followed by a *dynamically* controlled stage. Therefore any excessive EQ change can be ‘undone’ by the subsequent AGC or Limiter.

The last option, adjusting the **Mixer**, is designed to provide a final *minor* trim to the spectrum. If you’ve noticed that we calibrated these controls in 0.10 dB steps, then you know what we mean when we say these controls are for fine

trim! Since this stage is *after* all of the dynamic AGC and Limiting, a radical change in level in the *Mixer* will result in additional and possibly excessive clipping of audio in that band. We suggest that changes implemented here be limited to no more than about 1.0 dB. Naturally, the decrease in mix level can be done to any desired amount.

## Thunder Bass

Omnia-4.5 has the power to shake the walls with low end! If your source material has it, Omnia-4.5 will put it on the air, and with muscle! Making changes to this characteristic is done using the following parameters, and for maximum effectiveness, in the order listed:

1. In the Enhance Menu, increase the amount of *Deep Bass* or *Phat Bass* boost.
2. If *Phat Bass* has been increased, then increase the setting of *Phat Bass Tune*. This will help create a deep Bass register.
3. Increase the drives to the LF Limiters with the appropriate Drive controls in the Limiter XO screen.
4. Speed up the *Release* times of the LF *Limiters* sections.
5. In the *Clipper* sub-menu, set *Clipper Style* to *Girth*.

When it comes to processing, moderation is the key! If all of the above steps are utilized in the pursuit of more bass, then severe low frequency over-enhancement can occur. Excessive bass boost can produce the illusion that the presence and high frequencies have been lost. They are still there, but are being acoustically masked by the lower frequencies.

Another concern is the creation of bass-induced intermodulation distortion in the clipper. This artifact might be noticed on midrange/presence frequencies whenever a sustained bass note is present. An example of this would be a strong bass signal “underneath” a sustained vocal passage. The vocal passage will begin to sound as if it “warbles” a little bit. This is a sign that the over-processed bass energy is pushing the vocal frequencies in and out of the clipper unnecessarily. If this is happening, lower the *Bass Clipper Thresh* and set *Clipper Style* to *Girth*.

**Generally, an increase in the Enhance Menu's Bass boost functions alone will provide more than sufficient enhancement to the low end.**

# Chapter-6: Remote Control Software

The Omnia Remote Control software is a Windows (Windows 95, 98, NT 4.0, Win2k) software program that allows remote access to the Omnia-5EX processor adjustment using any PC running the aforementioned versions of Microsoft Windows®. Note that remote software for the Omnia-5EX is unique to that product, and versions of Omnia Remote Control for our other audio processors will not work with Omnia-5EX. The latest version of Omnia-5EX Remote Control Software is always available free of charge by pointing your web browser to the “Support” page of our web site: [www.omniaaudio.com](http://www.omniaaudio.com).

The Omnia-5EX Remote Control application looks very similar to the actual front panel of the Omnia-5EX. Before it connects to the Omnia, the words “OFF LINE” will be displayed where the Preset Name and System Time will be displayed once the remote connection is made. All metering activity is also at idle.

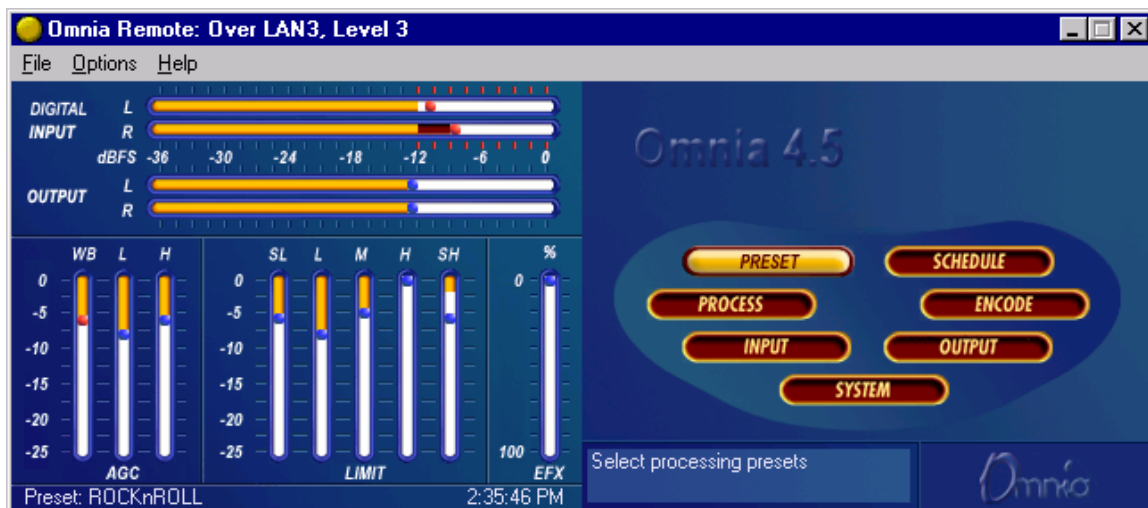

**Omnia-5EX Remote Control as it appears on your computer screen**

## Software Installation

Installation is simply a matter of putting a copy of **O5RemoteXXX.exe** into the folder name of your choosing, and running it from that location. This file is the actual raw executable so there is no “installer” and no permanent changes are made to your computer system or to your Windows registry.

Using standard Windows procedures, create a new folder by the name you wish to use, and place a copy of “**O5RemoteXXX.exe**” in that folder. You can then also create a desktop shortcut to that executable if desired.

When the program is freshly installed but has not yet been run, “**O5RemoteXXX.exe**” is the only file in the specified folder. However, the first time that the program is run, it will create a small new file called “connect.dat”, which contains your connection type information. When you first run the Omnia-5EX Remote Control program, there is no “connect.dat” file yet, so you will receive the error message “No connection database. Creating new database”. This is normal and is no cause for concern.

**Note:** When you install Omnia Remote Control software updates, you should move the old version and its associated connect.dat file to a new folder. This way, conflicts with different versions of the connect.dat database will be avoided. If you wish, the old version’s folder can be safely deleted once the update is complete. You will also want to use unique folder names for each copy of other Omnia remote control programs if you have those

*Omnia-5EX Use and Operation Manual – V: 1.1*

installed. Please note that the remote control programs themselves, as well as their associated *connect.dat* files are unique for each version of the Omnia Classic, Omnia 3, Omnia-5EX, Omnia-6EX and Omnia Toolvox.

## Setting Up and Configuring Omnia Remote Control

The Remote Control Program for the Omnia-5EX is specific to the Omnia-5EX. As stated earlier, Omnia Remote Control programs designed for our other Omnia family of products will not work with Omnia-5EX. The latest versions of all Omnia remote control programs are always available free of charge through the “Support” page of our web site: [www.omniaaudio.com](http://www.omniaaudio.com)

Start the Omnia5\_remote1.exe program. As mentioned earlier, when the program is run for the first time, you will get an error message saying: “No connection database, creating new database.” This is normal.

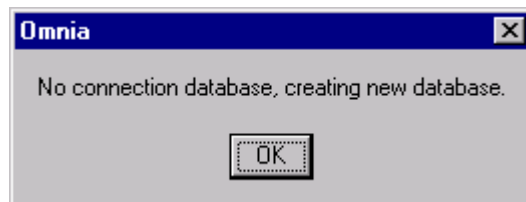

**This message is normal the first time the program is started!**

## Checking the Version Number of your Omnia-5EX Remote Control Program

You can check the version of your Omnia Remote control program by clicking on the “About” option under the “Help” menu option.

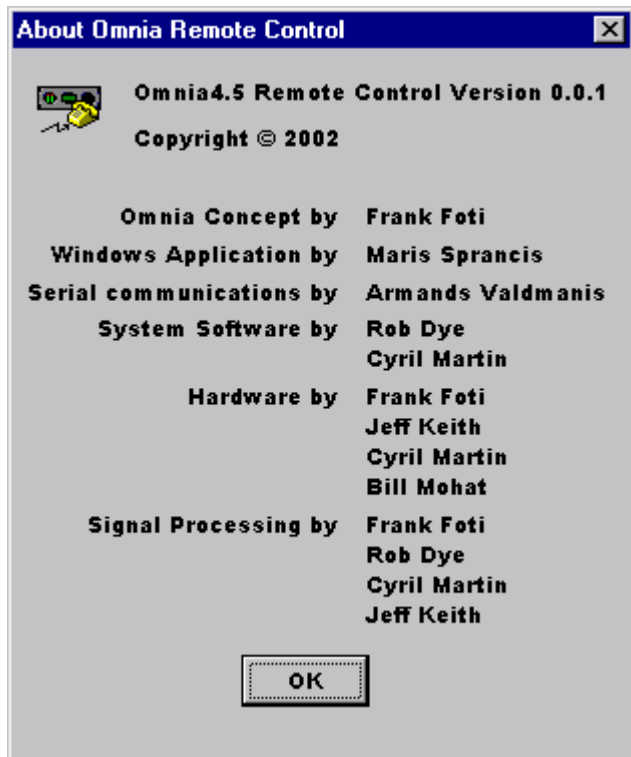

The Omnia-5EX remote Control Version number is shown here.

**The Omnia-5EX Remote Control “About” Screen**

## The Edit Connection Dialog Box

Under the Options Menu, select “Edit Connection”. A new window will open, and a default “New Connection” option will be displayed. Enter required information into each of the configuration boxes.

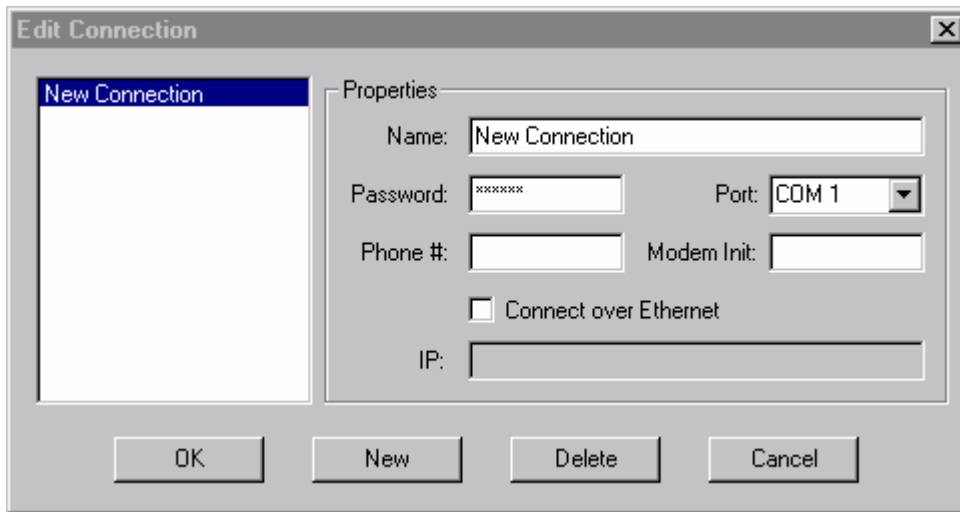

**Edit Connection Menu in Omnia-5EX Remote Control**

In the left side of the “Edit Connection” window will be the list of any connections that are currently contained in the 'connect.dat' configuration file. Connect.dat will be created in whatever folder the Omnia remote program is started from. The specific names in the list are derived from the information that was entered into the “Name:” box when each connection was first set up. In the Properties Window of the dialog box, it's a good idea to edit the connection name to match the type of connection you wish to configure. The three available connection types are:

- via Direct Serial
- via Modem
- via TCP/IP Ethernet

Connection names such as “Serial” if using the RS-232 port, “Network” if using the Ethernet port or “Dialup” if using a modem may be used. This naming convention is not mandatory, but it will help keep things tidy if you decide to use Omnia-5EX Remote Control to connect to several Omnia-5EX units.

(Note: Use **New** to create any additional connection entries. Use **Delete** to remove any unused entries. Select any entry in the connection list to edit its fields. Use **Cancel** to exit without making changes.)

To set up a connection:

1. Enter the name of the connection in the “Name” box. It is helpful to name the connections you create according to the Omnia they connect to, or even by the method of connection. For instance, the name box could contain entries like “WXXX Omnia”, “WYYY Omnia”, “WXXX Omnia by Modem”, “WYYY Omnia by Network”, etc.
2. In the password box, enter the login password for the Omnia-5EX that you wish to make a connection to. The factory default password for serial port and modem connections (only) is “tomtom” (all lower case). For Ethernet remote connections, the passwords are the same as the Omnia-5EX’s front panel passwords. The factory default for level 3 (full access) is “engineer” (all lower case). If you leave the password box blank, the Omnia will prompt you for the password each time you try to connect.

3. If you wish to connect over a network, you must check the box “Connect over Ethernet”. When you do this, the parameters required for direct serial or dial-in via modem will be grayed out. Then, only the TCP/IP address of the Omnia that you wish to connect to must be entered. Note: If you are connecting via Direct Serial or Modem, you should not check the “Connect over Ethernet” box!
4. If connecting via Direct Serial or Modem, then select the COM port that you wish to use on your PC. This COM port should be configured in Windows for the highest baud rate that your PC will support, but in any case, should be set to at least 57,600 bps.
5. If connecting via Direct Serial, no other information is required.
6. If connecting via Modem, in the “Phone #” box, enter the telephone number of the modem that is connected to the Omnia at the remote site. Any characters present in the “Phone #” box signal the Omnia Remote program to attempt a connection via modem!

If you need to use a Modem Initialization string, you may enter it into the “**Modem Init**” string box. If you require a modem initialization string and feel more comfortable building the entire connect string within the “Phone #” box you may do this. See “Using Custom Modem Initialization Strings” for more information.

If your connection attempt times out before the Omnia can answer, you can increase the value (in seconds) of the “**Connection Timeout**” setting. This value sets the amount of time the software will wait for the carrier tone from the Omnia’s modem before timing out and hanging up the computer’s modem.

Omnia Remote Control supports a wide variety of Hayes command set compatible modems. If you have difficulty using your modem, you may call Omnia Customer Support for assistance, but please gather as much information about your modem as possible before doing so.

## On the Omnia Side...

### Remote Control Using the Optional Omnia PCMCIA Modem

Before use, ensure that the Omnia-approved PCMCIA modem card is fully inserted into the lower PC Card slot on the back of the Omnia. Press on the modem card’s “XJACK” connector to extend the modular telephone jack. Using a standard RJ-11 cable, connect your telephone line to the Omnia modem. Make a note of the telephone number corresponding to this line, as you will need it later when you configure the Omnia Remote Control program.

**Note:** The modem card can only be safely installed and removed when the Omnia’s power is *off*. Only the PCMCIA modem card supplied by Telos Omnia has been tested and approved by Telos Omnia. We cannot ensure correct operation of any other modem card with the Omnia-5EX, nor can we provide support for such non-approved cards.

### Remote Control Using a External Hayes Compatible Modem

The Omnia supports nearly every Hayes command set compatible modem available. Please note that in order to support the widest possible variety of externally connected serial devices the Omnia-5EX’s RS-232 port does not support hardware or software handshaking. This is of no concern, and we are aware of no instances where this has prevented an externally connected modem from operating properly. The externally connected modem will need to auto-detect one of the Omnia’s three rear panel serial port’s baud rates (9,600, 19200, and 57,600). Because the Omnia and the modem are both DCE devices, you will need to use a crossover (null modem) cable between them.



## Using a Direct RS-232 Connection for Local Communications

When a computer can be located near the Omnia-5EX, it may be convenient to use a direct serial cable connection rather than dial up. Use a standard, straight-through serial cable - null-modem cables will not work! A typical serial cable will need a DB-25 male connector for the Omnia-5EX end, and probably a DB-9 female connector on the computer end. You should verify the exact type required by your computer.

## Remote Control Using a Direct Serial Connection

In the Edit Connection window, create a New Connection and name it. Then fill in the Password box (the default password is “tomtom”-lower case only!). The password may be changed at any time using the File Menu “Change Password” option. Note that you must be connected to the Omnia in order to change the password, and that the password change becomes valid the next time you attempt to log in with Omnia Remote control.

Select the COM port that your computer will use under the drop down list box labeled “Port”. If the Omnia and computer are connected by a straight through serial cable, you should be able to connect and control the Omnia-5EX locally using the remote control program.

The Omnia is designated as a DCE serial device, and has a DB-25 female RS-232 port connector. Your computer will typically be a DTE device, and will usually have either a DB-9 or DB-25 male connector. Since only connections between the same type of equipment require a null modem cable (DCE to DCE, or DTE to DTE), the Omnia to PC cable should be a straight-through type! A null modem cable will not work!

## Connecting via Modem

Configure a new connection, also entering the telephone number to which the Omnia-5EX’s optional Modem Card is connected. Then fill in the Password box (the default password is “tomtom”-lower case only!). The password may be changed at any time using the File Menu “Change Password” option. Note that you must be connected to the Omnia in order to change the password, and that the password change becomes valid the next time you attempt to log in with Omnia Remote control.

If your computer needs to dial an access code (such as “9”) to get an outside line, that digit must be entered as well. Sometimes if the outgoing connection passes through a PBX, it might require a short pause between the outside line access code and the telephone number you're dialing. In this case, the telephone number will need to have a comma inserted into it after the '9'. (In the standard Hayes command set, a comma is a “pause” character). You may use as many commas (pauses) in the dialing string as necessary to get whatever delay you require for your situation.

**Example:** suppose you need to connect to a remotely located Omnia and it is connected to telephone number 555-1234 in Area code 717. To make things more interesting, your local PBX system requires you to dial a “9” to get an outside line. In this case, you'll need to dial “9” to get an outside line, as well as a “1” because it is a long distance call. In this situation, the correct entry for the “Phone #” box would be:

**9,17175551234**

To enhance 'human readability', you could parse the telephone number entry with hyphens. Doing this has no effect on the ability of the program to dial out. The entry in the Phone # box entry would then be:

**9,1-717-555-1234**

## Using a Custom Modem Initialization String

A custom Modem Initialization String is sometimes required in order to control the behavior of the modem in special circumstances. While there are many different initialization string possibilities, the most common one modifies how the modem handles dial tone. Sometimes the modem may be connected to a circuit that does not provide the US standard 350/440 Hz dial tone, and in this case, you need to tell the modem to ignore it.

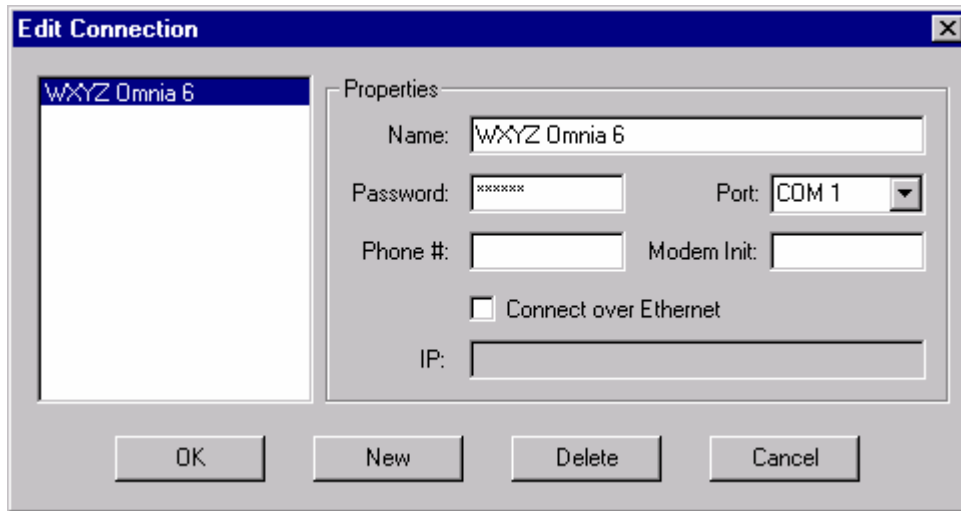

**Edit Connection dialog box with “Modem Initialization String” edit box**

The extra dialing commands that modify modem behavior should be entered into the “Modem Init:” box in the Edit Connections menu. If you are “modem init string savvy”, you could ignore the “Modem Init:” box altogether and place the complete dialing command string into the Phone # box. The choice is yours.

As pointed out earlier, a common customer need is the ability to tell the modem to ignore a non-standard dial tone. For that situation, the most commonly used options are:

- X0 - Disables both busy and dial tone detection.
- X1 - Disable busy and dial tone detection.
- X2 - Disable busy detection, enable dial tone detection.
- X3 - Enable busy detection, disable dial tone detection.
- X4 - Busy and dial tone detection enabled.

Given this information, a possible initialization string example configured to ignore the dial tone before dialing, could be:

**ATX0w,xyyyzzzz or ATX0w-,x-yyy-zzz**

Where “AT” is the start of the standard modem command string, and;

Where “X0” tells the modem to ignore busy and dial tone detection, and.

Where “x” is the number to dial to reach an outside line (if required), and;

Where “,” is a pause, and;

Where “**yyy**” is the dialing prefix, and;

Where “**zzzz**” is the dialing suffix.

There are many resources on the World Wide Web pertaining to the possible Hayes command set initialization string options. You can locate such resources by using the search text “Hayes Command Set” in your Internet browser. Two such sites with resources that have been helpful are:

<http://www.modemhelp.net/basicatcommand.shtml>

<http://www.modemexpress.com/>

## Using an Ethernet Network Based Connection

For Network connections, check the **Connect over Ethernet** box and enter the IP address of the Omnia-5EX in the box provided. The TCP/IP address entry format is: xxx.xxx.xxx.xxx. The default TCP/IP address of the Omnia-4.5 is 192.168.0.191.

Technical note: the Omnia-5EX Remote Control communicates with the Omnia-5EX using a Telnet session on Port 23. If you are unable to communicate with the Omnia through a network firewall, the first thing to check is whether traffic on port 23 is being permitted.

Enter the password for the unit in the Password box. If nothing is entered, you will be asked for the password at the time you connect to the remote Omnia.

The default passwords for Ethernet remote connections are the same as the front panel passwords:

- Level 1: “user” (all lower case)
- Level 2: “advuser” (all lower case)
- Level 3: “engineer” (all lower case)

These passwords can only be changed at the front panel of the Omnia-5EX.

The Remote Control software allows multiple connection profiles to be created so that a mix of connection types (Direct, Serial, TCP/IP) may be used. This allows the program to easily support communicating with different Omnias at different locations, connected by different means.

When all items have been entered, select OK.

Note: These connection settings are stored in a small binary file named *connect.dat* located in the same folder as the remote program.

## Upgrade Software Feature

You can use the Ethernet based connection and Omnia Remote Control’s special “Upgrade Front Panel” function under the Options menu to download the most current front panel (user interface) software features into the Omnia. To obtain the software update (.upd) file, visit <http://www.omniaaudio.com/support/updates.htm>. See Appendix D on Page 121 for detailed instructions on how to download the update file to the Omnia.

## Establishing a Remote Connection

To establish a connection with the remotely located Omnia-5EX, return to the Options Menu and select Connect, which brings up a list of connections you have defined. Double-click on the name of the desired connection, or highlight it to select it and press OK. The connection will be established after a short pause, and you should see the bargraph meters become active when a connection has been established.

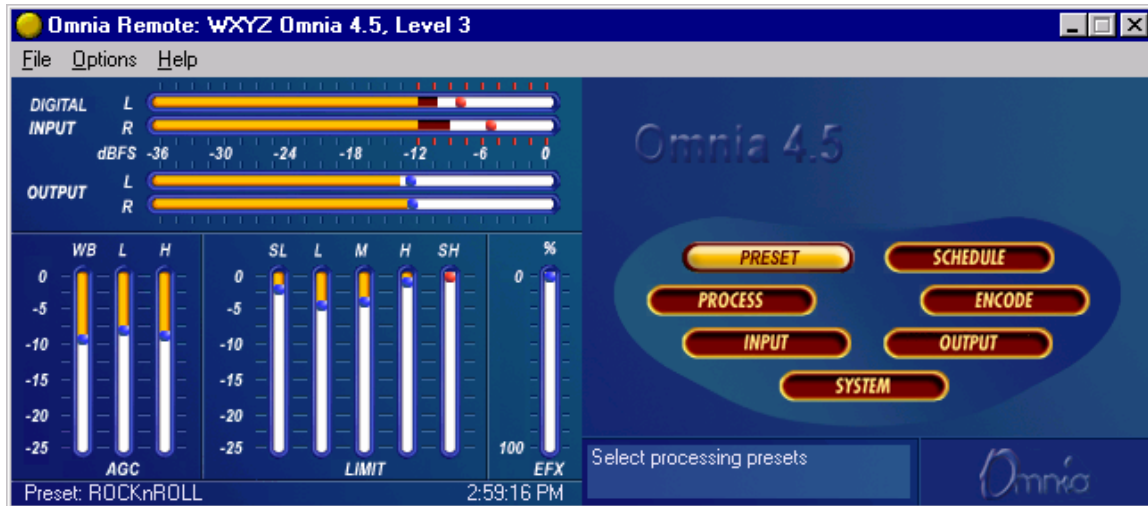

**Omnia-5EX Remote Control after connection is made. Note that the currently selected Preset and the Omnia's actual System time are being displayed.**

Use Cancel to leave the dialog box without making any connection.

You can choose to have the program automatically establish a connection by going to the Options Menu, selecting Auto-Connect to Last. Then the program will always connect to the Omnia-5EX using the last-used startup connection entry.

Note that if you have not entered a Password while editing the connection type, you will be prompted for it each time you connect to the Omnia!

## Terminating a Connection

From the Options Menu, select Disconnect. Closing the program will also terminate any connections.

## Operation

The Remote Control Program for Omnia-5EX looks very similar to the actual Front Panel and works similarly with some added enhancements:

- Multiple control windows may be open at the same time.
- The scroll wheel on mice so equipped is supported for fast, easy adjustment of parameters.
- The ability to save, load, and print presets and system parameters to the computer. (in the File Menu) This is very handy for reference and backup purposes.
- The ability to edit and load Trigger Scripts as described starting on Page 95.

## Using a Terminal Program and Direct Connection

It is sometimes useful to use a Direct Serial Connection and a terminal program such as Windows HyperTerminal to gain access to the Omnia's command line interface. While operating the Omnia in this manner is certainly not for beginners, the information that can be captured from the rear-panel RS-232 port, especially during system boot-up, can be very useful for troubleshooting purposes. Upon occasion, Omnia Customer Support personnel may ask you to capture such data from the rear port if it seems necessary.

The serial communications parameters of the terminal program should be set to:

- 8 Data Bits
- No Data Parity (None)
- 1 Stop Bit
- Flow Control (None)

The Baud rate (bits per second) must be set to match the setting in the Omnia-5EX's System Menu. Make sure however that the maximum allowed baud rate (set in the Windows Device Manager) of the serial port being used is set *at least* as high as the desired baud rate. Setting this to the highest available setting is fine.

Once these parameters have been set, one can now log onto the Omnia-5EX by typing "login tomtom" (enter) at the >> prompt. If the >> prompt does not show up, try typing "echo on" (enter).

# Trigger Interface and Script Editor

## Overview of the Trigger Script Editor

The Omnia-5EX Remote Control software contains a special script editor that allows the programming of complicated system parameter changes which can be “triggered” by logic state changes on the rear-panel “Interface” connector.

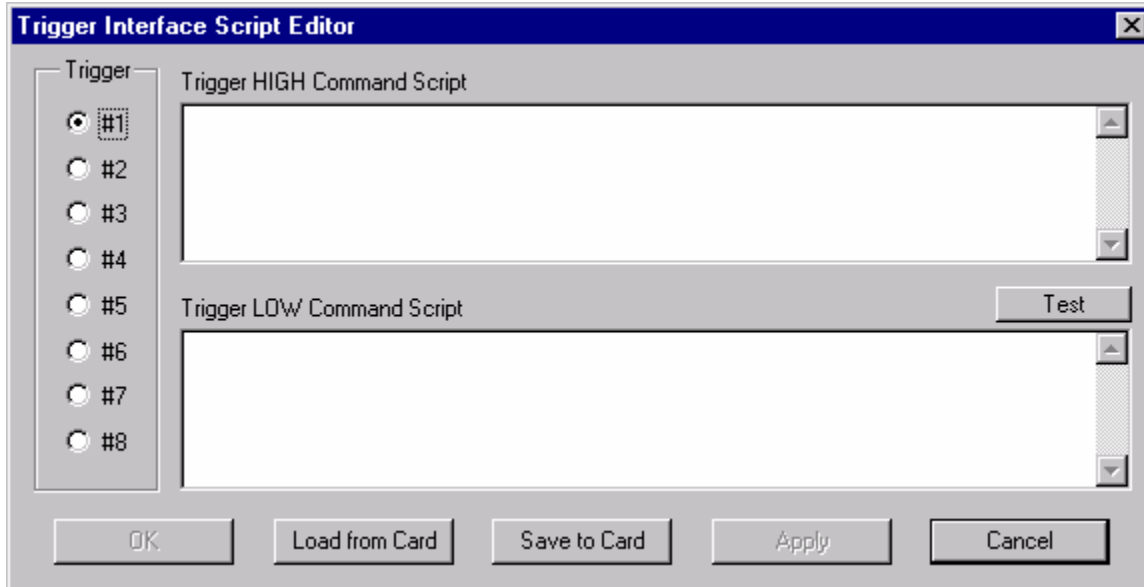

**“Edit Trigger Scripts” dialog box as opened under “Options”, “Edit Trigger Scripts”**

Using Trigger Scripts, you can make the Omnia-5EX do things with contact closures that would normally need to be done either by manual intervention at the front panel, or via Omnia-5EX remote control. There are EIGHT Trigger Inputs available, and they respond to voltage levels on the rear-panel “Interface” connector.

## Trigger Control by Dry Contact Closures

The simplest way to manipulate a Trigger Input is through simple contact closures to ground. Connecting a Trigger Input to ground initiates the programmed function associated with the “Trigger LOW” command, and moving the connector pin from a grounded to a floating condition issues the “Trigger HIGH” command.

## Trigger Control by Applied Voltages

The Trigger Inputs are also capable of operating with a DC voltage applied, as long as such voltage does not exceed 25 volts DC. Applied voltages that are more than +1.25 volts DC on the trigger input result in a Trigger HIGH state, while voltages less than +1.25 volts result in a Trigger LOW state. Therefore, if +12 volts DC is applied, a logic “1”, or Trigger HIGH is sensed. If -12 volts DC is applied, a logic “0”, or Trigger LOW is sensed. When nothing is connected to the Trigger Inputs, they normally float at approximately 3.5 volts, which is a logic HIGH.

## What Can Trigger Scripts Control?

Virtually any aspect of the Omnia-5EX operation can be controlled using the Trigger Script function. Therefore, we'll explain some of the different types of operations that can be performed, and the different types of commands that are required to perform each one.

## Some Common Usage of Trigger Scripts

- Switch from Stereo to L+R Mono
- Switch from L+R Mono to Stereo
- Switch the Stereo Pilot off
- Switch the Stereo Pilot back on and at 9% injection
- Switch the Omnia's audio input source from Analog to Digital
- Switch the Omnia's audio input from Digital to Analog

## The Para, The Syspara, and Command Line Entries

### What Is A “Para”?

In general\*, a 'para' is a variable that corresponds to one of the adjustable controls available within a Processing Block. For instance, the Wide Band AGC Release Time is a 'para', in fact, it happens to be 'para' 665.

### What Is A “Syspara”?

In general\*, a 'syspara' is a system parameter assigned to the basic operation of the “System”. Controls such as the one for audio source selection, the mono operating mode, and the stereo pilot state and its injection level, each have a “syspara” value associated with it. A complete list of Omnia-5EX HDFM 'syspara' values can be found on Page 99.

\* In the above explanation, we used the disclaimer “in general” because there are certain exceptions.

### What About Command Line Entries?

Just as 'paras' and 'sysparas' can manipulate the processing controls and system adjustments, there are higher level commands available which do even more special things. Later, we'll discuss how the command line can be used to manipulate the Daypart Scheduler.

### Using The Trigger Script Editor

A Trigger Script is “written” using the Trigger Interface Script Editor which is contained within the Omnia Remote Control software. The Script Editor runs in a separate window from the Remote Control window. The Editor window is opened under the Options menu (Edit Trigger Scripts). To open the Script Editor window, the computer running the Remote Software must be connected to and communicating with the Omnia-5EX.

Starting the Script Editor (Options / Edit Trigger Scripts) opens up the Script Editor window. The eight radio buttons along the left side select which trigger script number to display and edit. The top edit box shows the script for the Trigger HIGH Command Script (contact open) for the selected input. The bottom edit box shows the script for the Trigger LOW Command Script (contact closure) for that input.

Once a script has been entered, clicking the Test button checks the script syntax, and if correct, sends the displayed script to the Omnia-5EX for immediate execution. Use the command line window and/or any alert dialogs that pop up to view the success or failure of the script. Note that executing the script in this manner does not result in the script being downloaded or saved as a trigger script, it is simply run once to see if the script, as written, actually works.



The buttons along the bottom of the window load, save, or download the current scripts being edited to the PC Card. Click “Save to Card” to permanently store the current scripts on the PC Card in one file. Click “Load from Card” to retrieve previously saved scripts. To download the scripts for use in the processor without saving to the PC Card, click “Apply” if further script editing will be done. Click “OK” to download the current scripts and close the Script Editor window. Click “Cancel” to close the window, discarding any changes made since the last “Apply” or “Save to Card.”

Note: If you have created Trigger Scripts and clicked “Apply” but not “Save to Card”, the Omnia will only remember your scripts until you power it off.

Once the scripts are downloaded into the processor, they are executed when the appropriate logic transition occurs on their assigned trigger input. Neither the Remote Control application nor the Script Editor need to be connected for the trigger scripts to execute.

**Note:** When a trigger script is actually executed, any problems that may be encountered in the execution of it will not be noted to the user.

## Script Command Definitions

The scripting commands available for use with the Daypart Scheduler are listed in bold lettering (e.g., **parts**). Their definitions (e.g., Displays the current daypart table) and usage examples are also listed. The commands have been divided by general functions (Dayparts, Presets, System parameters, etc.). In use, a command is typed in and then the enter or return key is pressed. If the command is executable (e.g., **parts**), then the command is run (e.g., a table of the dayparts is displayed), otherwise the cursor simply moves to the next entry line.

### Dayparts

**parts** Displays the current daypart table

**partadd** <day> <time> Adds a daypart to the daypart table.

The “day” parameter can be assigned the following days: Sun, Mon, Tue, Wed, Thu, Fri, Sat, M-F, S-S, All. The “time” parameter must be defined using the following format: <hour>:<min>:<sec><am | pm> . As an example, typing **Partadd Mon 5:00:00am** <enter> commands the Omnia-5EX to add a daypart on Monday at 5:00:00am.

**partremove** Removes a daypart from the current daypart list.

Example: **partremove Mon 5:00:00am** <enter>

**partload** Loads a daypart from the PC Card.

**partsave** Saves the current daypart to the PC Card.

### Presets

Note: After a preset is saved to the system, the Omnia knows them by their Index Number, not by their Preset Name. Therefore, when selecting a preset, you use its index number. When saving presets, you use its name!

**presets** Lists all the currently available factory and user presets by index #.

**preset** <preset index #> Selects the preset by index # from the list of available presets

Example: **preset 21** <enter> commands the Omnia-5EX to load preset number 21 in the index list.

**delete** <preset index #> Deletes a preset from the preset index list by its index number.

Example: **delete 21 <enter>** commands the Omnia-5EX to remove preset number 21 from the index list.

**rename <preset index #><name>** Renames the preset by its index number.

Example: **rename 21 BOOGY <enter>** commands the Omnia-5EX to rename preset number 2.

**save** Saves the preset under its current name.

Note: Factory presets are permanent and cannot be written over. You must use the ‘**saveas**’ command when saving changes made to a factory preset in order to save it as a unique name.

**saveas** Saves the preset under a different name.

Example: **saveas BOOGY <enter>** Commands the Omnia to save the current settings as preset BOOGY.

## Non-System Parameters (paras)

**paras** Lists the modifiable parameters available for the current preset in a table format.

Example: **paras <enter>** displays the parameters for the current preset:

**paravalues <index #>** Lists all possible values for the parameter at the given index number.

**para <para index #> <paravalue>**Sets a new value for the selected parameter.

## Omnia-5EX System Parameters

A 'syspara' is an Omnia-5EX System parameter. The System Parameters are assigned to controls which govern overall operation, such as Input and Output Gains, Pre-emphasis/De-emphasis, etc. These parameters would NOT be saved with individual presets, but instead are saved using the Save To Card option in the System menu.

To obtain a list of all System parameters, you use the command '**sysparas**', which lists all of the adjustable parameters in a table format with their current setting value in brackets. Example: typing **sysparas** <enter> displays the following table:

1) Input Source [AES/EBU]	2) Mono Mode [Stereo]
3) Input Phase [Normal]	4) Input Master [0.0dB]
5) Input Left [0.0dB]	6) Input Right [0.0dB]
7) Master Drive [12]	
17) Output Master [+10.0dB]	
18) Output Left [+10.0dB]	19) Output Right [+10.0dB]
20) DAB Master [+10.0dB]	21) DAB Left [+10.0dB]
22) DAB Right [+10.0dB]	23) Analog Out [FM]
24) AES Out 1 [FM]	25) AES Out 2 [FM]
26) Headphones [-10.0dB]	33) Daypart State [Enabled]
34) Ctrl Port baud [19200]	51) Composite 1 [3.60v]
52) Composite 2 [3.60v]	53) SCA Level [-20.0dB]
54) Pilot Level [8.0%]	55) Separation [Stereo]
56) Phase Adjust [0 Deg]	57) Analog Phase [1]
58) Preemphasis [75 uS]	59) Deemphasis [75 uS]
60) BS412 [OFF]	61) Ave. Power [83]

## Setting New Syspara Values

To find the new value you wish to use for a particular Syspara:

**sysparavalues** <syspara index #> Lists all the possible values for any parameter.)

Example: **sysparavalues 54** <enter> Displays a table listing the possible Pilot Level values.

To set a new value for a Syspara:

**syspara** <syspara index #>[<sysparavalue index #>]

To reset all System parameters back to their factory defaults:

**sysdefaults** Restores the system attributes back to their factory defaults.

To save all System settings to the rear-panel memory card.

**syssave** Saves the system attributes to the Omnia PC Card.

To load the saved setting from the rear-panel memory card:

**sysload** Loads the system attributes from the currently inserted Omnia PC Card.

## Creating a Trigger Script

Now that the scripting commands have been defined, let's put them to work to create a Trigger Script. We'll use one of the most commonly requested operations that FM broadcasters want to easily accomplish: switching between mono and stereo operation.

This procedure can of course be done by manually using the Omnia-5EX front panel controls to turn off the 19 kHz pilot tone and to switch the input from stereo to mono left. But a far easier method is to use the Trigger Script Editor to create two scripts that can be loaded into the processor to run in response to a single relay contact closure or open. The following scripts do just that—set the Omnia-5EX to automatically switch to mono in response to a sustained contact closure and to then return to stereo operation when that same contact is opened.

In scripts, all lines that begin with “syspara” must be followed by two numbers that identify the parameter ID number that is being set and that ID number's new value. The value numbers and their settings for the Pilot Level were also shown. To list the values and parameter settings for any parameter, type in **sysparavalues** followed by a space and then the parameter's “syspara” number.

(The “sysparas” table lists all of the available system parameter numbers.)

## Trigger Script Example for Switching to Mono Operation

In this example, we'll configure Trigger Input #1 to switch the Omnia-5EX into mono operation when the contact closes and switch back to stereo when it opens again. To create this script, open up the Script Editor and click radio button #1. Now click in the lower edit box to begin entering the Trigger 1 “Trigger Low” script. Type:

**syspara 54 1 <enter>**

This command sets the processor to turn off the 19 kHz pilot tone when it is run. “**syspara 54**” says to edit the Pilot Level. The “**1**” says select Off. Next, type in:

**syspara 2 2 <enter>**

This command sets the processor to switch the input to “mono left” when run. “**syspara 2**” says to edit the Mono Mode setting. The “**2**” says select mono left.

When you are finished, the contents of the Trigger LOW Command Script box should look like:

**syspara 54 1**

**syspara 2 2**

If you wanted to use the sum of Left and Right channels for your mono source, we would have entered the command '**syspara 2 4**' instead of '**syspara 2 2**'.

## Trigger Script Example for Switching to Stereo Operation

Now we'll create a Trigger High Command Script, which will return the Omnia to stereo operation and put the pilot back to 9% injection when the switch contacts open. In the Trigger HIGH Command Script box type in:

**syspara 54 32 <enter> (syspara<space>9<space>32**

This tells the processor to activate the 19 kHz pilot with the injection level set to 9.0%. “**syspara 9**” says to edit the Pilot Level. The “**32**” says select 9.0% pilot level. Now type in:

**syspara 2 1 <enter>**

This tells the processor to switch the input to “Stereo.” “**syspara 2**” says to edit the Mono Mode setting. The “**1**” says to select stereo mode.

When you are finished, the contents of the Trigger HIGH Command Script box should look like:

**syspara 54 32**

**syspara 2 1**

These four commands are now a completed script for Trigger 1. To test the scripts, click the Test button above each edit box. If no errors or other displays are shown, then your script is ready to be used or saved. An error indication typically indicates you have a “typo” in one of your command lines. Verify the command is correct and that the index numbers for the parameters or parameter values are correct.

In order to use the scripts, they must be loaded into the Omnia-5EX. This is done by clicking Apply. Previously entered scripts in the Omnia-5EX’s memory are then replaced by your new scripts. To save the edited Script Editor scripts to the PC Card, click Save to Card. To recall previously edited scripts, click Load From Card. These can then be sent to the Omnia-5EX by clicking Apply.

To actually use the scripts you have just written requires that a sustained relay or a switch be connected between trigger input 1 (pin 1) and ground (pin 5) on the Interface connector on the processor's back panel. Setting the relay or switch on (shorting pins 1 and 5 together), then causes the Omnia-5EX to follow the script for go low (the unit switches to Mono Left/Pilot off operation). Opening the switch or relay will then cause the processor to follow the go high script (the unit switches to stereo/pilot on operation).

Multiple operations, including ones that are vastly more complicated than what we have presented here, such as simultaneously changing to different presets when changing from stereo to mono, can be completed at the flip of any one of the eight switches or relays connected to the Omnia-5EX. And the eight relays or switches do not have to be switched locally: Commands can even be initiated by a network satellite when a receiver with contact closures is being used.

## Different Ways to Use the Script Commands

There are two methods of using the script we just created. One is to use the scripts as Trigger Scripts, responding to contact closures and opens as previously discussed. The other involves integrating the scripts into the Omnia-5EX’s daypart table. Because the processor is flexible, it allows one to use the same script for both options.

## Initiating Trigger Scripts via the Interface Connector

As we mentioned, trigger scripts give the user the ability to tie a series of commands to a simple high/low logic change occurring on a pin of the 9-pin D-sub Interface connector on the unit's rear panel. The pins on the Interface connector are assigned as follows:

PIN 1 - activates Trigger Script 1

PIN 2 - activates Trigger Script 3

PIN 3 - activates Trigger Script 8

PIN 4 - activates Trigger Script 6

PIN 5 - is connected to ground

PIN 6 - activates Trigger Script 2

PIN 7 - activates Trigger Script 4

PIN 8 - activates Trigger Script 7

PIN 9 - activates Trigger Script 5

Each pin that is to be used must first be programmed with a trigger script for the desired Go High and Go Low logic. To execute the Go Low script, a trigger input pin is connected via a sustained contact closure to pin 5 (ground). To execute a Go High script, the ground is removed from that pin. Each of the trigger pins (1, 2, 3, 4, 6, 7, 8, 9) is thus connected through a switch or relay to the Omnia-5EX's ground on Pin 5.

Let's review what we created for the example we showed you under "Using the Script Editor". Whenever pin 1 is held low (the contact or switch is in a closed state), the Omnia-5EX will switch to and stay in mono mode (no Pilot and only the left input channel is used). When the pin 1 contact is subsequently opened, the Omnia-5EX will switch back to and stay in stereo operation (pilot on and both left and right input channels being used) as long as the contact is open.

### "One Way Script" Functions

You may also create scripting functions that do NOT return to another value when the remote contacts are opened. To do this, you use the Go LOW script only, and do not put any entries into the Go HIGH script.

Two possible uses for this very useful "Go LOW Only" Trigger Script trick are periodically setting the Omnia's system time to an external standard, and remote re-booting of the Omnia.

To use the Omnia's command line "Time" function to reset the Omnia's System Clock to midnight based on an external contact closure (such as from an automation system or other time reference), the Trigger Script script syntax would be:

**Time 00 00 00** Sets the Omnia time to midnight. Note that colons are not used as delimiters in this entry!

Although time is displayed by the front panel display and its controller, it is actually being kept by the Omnia motherboard. When resetting the System Time using trigger scripts, the change takes effect immediately at the motherboard. Because the front panel 'fetches' time synchronization from the motherboard every few seconds, the front panel's confirmation of the time change may lag by a few seconds but the two will agree with each other when updating takes place.

Another possible use of the one way Trigger Script script capability (although not strongly recommended) is the remote 're-booting' of the Omnia. In that special case, there would be no Go High script entry. The Go Low script for that function would simply read: **warmboot**

Remote re-booting of the unit carries with it several caveats:

- There will be a loss of audio while the system restarts. Analog and composite audio will continue to run for approximately nine seconds, and then nine seconds of no audio will elapse while the DSP code is reloaded.
- If Omnia Remote Control is connected by a modem or direct serial connection at the time, it will be disconnected and manual intervention will be required to reconnect.
- If Omnia Remote Control is connected by Ethernet at the time, the meters on Omnia Remote and Omnia front panel will freeze. However, when the Omnia Remote control session is disconnected, normal Omnia front panel operation will be restored. Manual intervention will be required to restart Omnia Remote Control.
- If you have not saved the System or Trigger Script settings, they may be permanently lost. Preset adjustments are saved in NVRAM and are not lost at power down.

## Initiating Scripts via the Daypart Scheduler

The Daypart Scheduler is typically used to change a Preset at a set day and time. But, when a script is added to the Daypart table, the script can dynamically change one or multiple attributes when the Daypart is executed. A script for use by the Daypart functions is written using the special script editor built into the New or Modify Schedule window in the Remote Software (Only) and the syntax is the same as for the Trigger Scripts described in the previous section.

The Daypart Scripts editor is accessed from the New or Modify Schedule window by highlighting and clicking on the **Scripts** button. There are also **Test** buttons on the page to force the Omnia-5EX to immediately run the current Start Script or End Script.

At the bottom of each editor window is a check box to enable or disable the use of the script. A script may be entered but will not be executed until the enable box is checked. The **Preset** check box can be used to disable the action of changing the preset when the daypart executes. Un-check this box when you want a daypart to execute *only* the given scripts and *not* change the preset. A daypart can actually be disabled completely by un-checking the **Preset, Enable Start Script Execution** and **Enable End Script Execution** check boxes.

Start scripts execute at the beginning of a daypart, before making a preset change (if any). End scripts execute at the end of the daypart, after making any preset changes. The script information is stored and retrieved in the same means as other daypart information.

Dayparts can still be selected, etc. from the Omnia-5EX front panel interface. However, dayparts with scripts cannot be modified in any way from the front panel.

**Note:** Remember not to include any commands, which may potentially prompt the user since a user may not be at the Omnia-5EX when the commands are executed.

**Note:** The remote control application does not have to be connected in order for the scripts to execute.

# Chapter-7: Troubleshooting your Omnia-5EX

Operational problems with the Omnia-5EX can sometimes be diagnosed using the rear-panel RS-232 port and a common terminal communications program. Detailed information about the Omnia's boot-up progress may be observed at its rear-panel RS-232 port, as well as viewing of any error messages that may be encountered. This chapter explains the various boot up and error messages that may be encountered while troubleshooting the unit. We'll cover some basic troubleshooting techniques for isolating possible Omnia-5EX problems in the field, and also how to obtain help or repair service from Omnia.

To take complete advantage of this functionality, you only need a standard terminal program for DOS, Windows, or other operating system. It must be configured for a default baud rate of 19200, no hardware handshaking, and using a terminal emulation for VT100. At Omnia, we commonly use the Hyperterminal<sup>®</sup> program that ships with Microsoft Windows<sup>®</sup>, but you can use whatever program you are familiar with. Please see the examples below for how we've set up our connection:

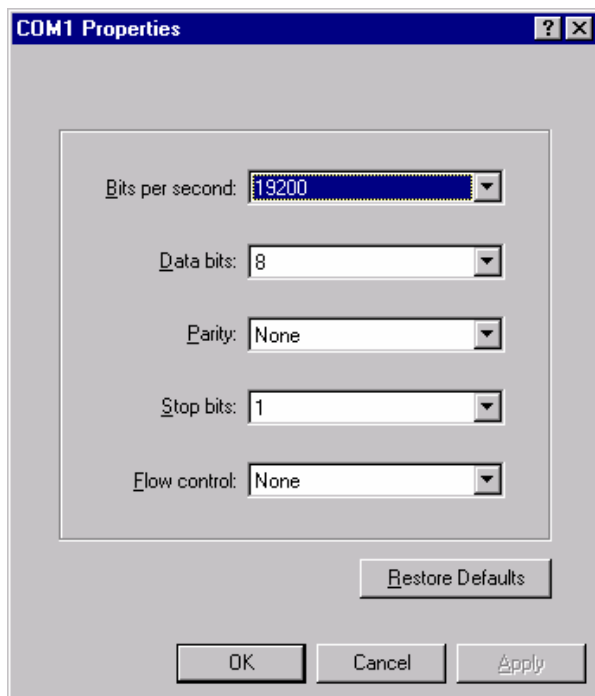

**Port Setup Parameters**

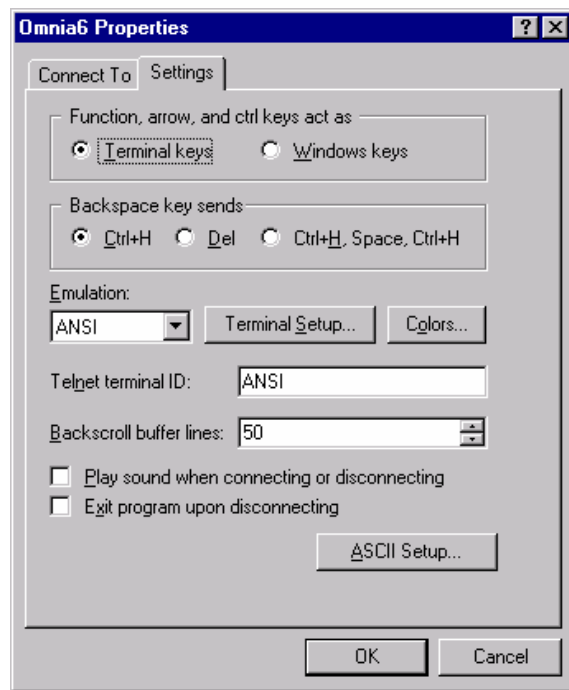

**Terminal Emulation Parameters**

Once these parameters have been entered and saved as a connection profile, they can be used to capture and display (and print) the output of the Omnia-5EX's RS-232 serial port during boot up. See the next page for an example of a normal Omnia-5EX boot up...



## Normal Boot-up Message

A healthy Omnia-5EX will transmit the following text on the rear panel serial port during boot up:

```
Omnia BIOS Software 1.13
Work : BIOS v1.13...
Work: Downloading OS...
Work: Downloading OS...
Work: Downloading OS...
Work: Downloading OS...
Work: Downloading OS...
Work: Downloading OS...
Work: Downloading OS...
Work: Downloading OS...
Work: Downloading OS...
Querying motherboard...Rev. G or higher motherboard detected.
Work: Omnia 5.00.00...
Work: Omnia 5.00.00...
Work: System Storage...
Work: Omnia Card...
Work: Preset Table...
Msg: System: FM45 -- common: 1 specific: 1
Msg : set preset RocknRoll (alg old:(null) alg new:fm_5band)
Work: Load Algorithm...
Work: Load Algorithm...
Work: Load Algorithm...
Work: Load Algorithm...
Work: Load DSPs...0
Work: Load DSPs...1
Work: Load DSPs...2
Work: Load DSPs...3
Work: Load DSPs...4
Work: Load DSPs...5
Work: Load DSPs...6
Work: Load DSPs...7
Work: Load DSPs...8
Work: Load DSPs...9
Work: Load DSPs...9
Work: Done!
Work: AES/EBU...
Work: IO Card...
Work: Command System...
Work: Graphics...
Work: Graphics...
```

## Audio Failure Alarm

If no audio is applied to the Omnia, the following messages will be transmitted next on the RS-232 port, approximately twenty seconds after boot up:

Flr : Audio failure: left input

Flr : Audio failure: right input

Flr : Audio failure: left output

Flr : Audio failure: right output

In the absence of an audio source, these “Audio failure” messages are normal. Note that the Omnia's audio failure trigger level is  $-37.5\text{dBFS}$ , and the signal must remain at or below that level in order for the silence detect algorithm to time out. It is possible to see these messages during normal programming if the audio input level happens to fall below  $-37.5\text{dBFS}$  and remains there until the audio fail algorithm times out.

## Audio Restoration Alarm

Approximately five seconds after audio has been restored to levels above  $-37.5\text{dBFS}$ , the following messages will be seen:

Flr : Audio restored: left input

Flr : Audio restored: right input

Flr : Audio restored: left output

Flr : Audio restored: right output

Note that it is possible for there to be audio *Output* failure messages but no audio *Input* failure message. This means that the unit is detecting applied audio at its Inputs, but that there is no output from the DSP chain.

From the perspective of signal flow, the Input meters follow the input level adjustment controls (Input Menu). This is also where the input to the Input Audio Failure comes from.

## Diagnostic and Error Messages

In the event that you need to contact Telos / Omnia Customer Support for assistance, please see the section entitled Obtaining Service on Page 111 for contact information.

The following error messages will appear on the front panel screen:

### **Insufficient Memory! Save As Failed.**

**Description:** This error will occur when trying to save a new preset while there are already 50 presets (including factory presets) on the rear-panel PCMCIA card.

**Cause:** Too many presets are saved to the rear-panel software card.

**Resolution:** Delete a preset or two and then try the save operation again.

### **Invalid password. Please contact Telos Systems Technical Support!**

**Description:** The front panel cannot “log in” to the motherboard.

**Cause:** This is usually caused by a front panel / rear panel version mismatch.

**Resolution:** Be sure that the rear panel memory card software version is correct for the currently installed front panel software version. If it is, or you are unsure, contact Telos / Omnia Customer Support for assistance.

The following messages will only appear on the rear panel RS-232 Serial Port:  
See Pgs. 105-106 for instructions how to access the serial port messages.

### **Work: Insert card to continue!!!**

**Description:** The operating system cannot see the rear-panel PCMCIA memory card.

**Cause:** The rear-panel PCMCIA card is missing or not fully seated.

**Resolution:** Turn the power off and make sure that the card is fully inserted into the **top** card slot with the large Omnia label facing up and the version number sticker facing down. The PC Card is keyed to prevent improper insertion. Gently press the card into the slot until the black release button, to the right of the card, pops out about 1/2" [12.70 mm]. This indicates the card is properly seated in the PCMCIA slot. If the card is properly seated and this error still appears, contact Telos / Omnia Customer Support for assistance.

### **Card does not have valid OS!!!**

**Description:** The contents of the rear-panel memory card do not match what the operating system expects or there is no bootable image on the card.

**Cause:** The card may be damaged, its data corrupted or it may contain the wrong software version.

**Resolution:** Try a new rear-panel memory card of the correct software version for your unit.

### **No previous system found in memory**

**Description:** The contents of the non-volatile RAM on the motherboard do not match what is on the rear-panel memory card.

**Cause:** This error may show up when the Omnia is booted up for the first time with a new rear-panel software card or when the Omnia booted up for the first time after the non-volatile memory (NVRAM) has been cleared, such as after replacement of the battery.

**Resolution:** Simply click OK in the error dialog box and the error should clear. If not and the Omnia continues to show this error at each boot-up, contact Telos / Omnia Customer Support for assistance.

### **NVRAM failure**

**Description:** The operating system was unable to write to the non-volatile RAM on the motherboard.

**Cause:** The NVRAM on the motherboard may have failed.

**Resolution:** Contact Telos / Omnia Customer Support for assistance.

**Failed to initialize RTC**

**Description:** The operating system could not initialize the Real Time Clock on the motherboard.

**Cause:** The Real Time Clock chip on the motherboard may have failed.

**Resolution:** Contact Telos / Omnia Customer Support for assistance.

**Dead battery, data lost.**

**Description:** The Lithium battery used for system configuration backup is being reported as dead or battery voltage is too low for reliable operation.

**Resolution:** Contact Telos / Omnia Customer Support for assistance.

**Timed out loading DSP.****Failed DSP #x Bootstrap, contact CE.**

**Description:** The operating system was not able to initialize one of the Omnia's DSP cards or one of the two DSP IC's on the card.

**Cause:** One of the DSP cards or DSP chips may have failed.

**Resolution:** Contact Telos / Omnia Customer Support for assistance.

**Host command bit not clear****ERROR: read failed write address, DSP #x**

**Description:** The operating system was unable to communicate with the DSP's host port.

**Cause:** Possible failure of DSP or motherboard DSP controller / router chain components.

**Resolution:** Contact Telos / Omnia Customer Support for assistance.

**Failed Routing, contact CE.**

**Description:** The operating system was unable to establish the correct signal path routing through the DSP chain.

**Cause:** Possible failure of motherboard DSP controller / router chain components.

**Resolution:** Contact Telos / Omnia Customer Support for assistance.

## Electrical and mechanical safety note!

When the Omnia is operated with its chassis top cover removed, you are exposed to potentially lethal voltages and high speed rotating fan blades.

Before attempting to make voltage measurements, be forewarned that the power supply heat sinks are connected to the AC power line. The LCD backlight inverters on the front-panel controller board have an output of around 700 volts! Do *NOT* attempt to measure them.

Avoid these areas whenever the AC power cable is attached to the Omnia. Never attempt to make measurements when the power supply's safety cover is removed, or near the LCD inverters on the front panel controller PC board!

Be forewarned that the two fans present a serious hazard to fingers, tools, and meter probes. The fan blades rotate at high speed and have very sharp edges. They can quickly and easily remove a fingertip (gee ... how do we know this?) Coming into contact with a rotating fan blade will cause serious injury.

When reinstalling the top cover, make certain that all thirty screws are replaced, and that they are tightened to a snug fit. Operating the unit with its cover removed or without all of the retaining screws will void your warranty and may compromise the ability of the Omnia to operate in high RF environments.

## Narrowing down problems

When actually troubleshooting your Omnia-5EX, try to ascertain some preliminary information first before embarking on an in-depth problem-solving mission. Take time to carefully consider whether your unit falls into any of the following states:

**1. The unit is totally dead.** Is the power on? Is the line cord plugged into an outlet that has AC power? Is there an audio input level? Is there an audio output level? Is there a power indication? Are the LCD screens blank, scrambled, or not illuminated? Symptoms like these might indicate a power supply problem. If you wish to examine the power supply, be aware that it is *switching* type, and therefore requires a load in order to start up and operate properly. Voltages measured when the power supply is not connected to the Omnia motherboard may not be correct.

**2. The unit has power, but there is no audio output although the processing bargraphs are working.** The first thing to verify is whether the front panel jog-wheel is operational. Verification of front panel operation helps narrow down where the problem is. Look at the levels display. If there is input audio but no output audio indications, try cycling the unit's power. If that doesn't bring the operation back to normal, then a hardware failure of some sort has occurred. If you get output levels but have no output audio, verify that the outputs are connected correctly. An analog output connected to a digital device, or a digital output connected to an analog device won't pass audio! Connect the appropriate test generator to the output cables to verify analog/digital audio is making it to the next device.

The next condition to check is to see if the failure has caused the processing to cease. Using program material, check to see if the processing bargraphs are operating. If they are, then it's a good indication that the basic DSP structure is sound and the system's host processor is working. At this point, it would be a good idea to see if the loss of audio is confined to only one output port, e.g. a composite output, the discrete left/right outputs or the AES/EBU output. Check the signal at each of these locations. If the signal is dead at all three, then this points to a digital audio problem after the dynamic processing DSP chips. If one of the output sections is not operating, then it can be localized to that specific section.

**Note:** The composite outputs and the discrete left/right outputs are operated from their own specialized Digital to Analog converters. Therefore, it's possible for one type of output to fail without affecting the other. Likewise, a failure in the AES/EBU driver section could result in the digital output being dead, while the rest of the system is operational.

**3. Unit has power, but no audio and no processing indications.** Check to make certain that the Input Source selected in the INPUT menu is correct for the input type being used. If so, then there may be some form of problem within the DSP environment, the host microprocessor or a combination of both. We recommend that you contact Telos / Omnia Customer Support for assistance. Please see the section entitled Obtaining Service on Page 111 for contact information.

**4. Unit powers up but the front panel display shows the rotating Omnia logo and then stops.** This indicates a communications error between the front panel and the master motherboard CPU. If the unit is properly passing audio it is likely that the problem is Front Panel related. If the unit is not passing audio it is likely that the problem is Motherboard related. Turn the power off and make sure that the rear-panel PCMCIA software card is fully inserted into the *top* card slot with the large Omnia label facing up and the version number sticker facing down. The PC Card is keyed to prevent improper insertion. Gently press the card into the slot until the black release button, to the right of the card, pops out about 1/2" [12.70 mm]. This indicates the card is properly seated in the PCMCIA slot. If the card is properly seated and boot-up still stops at the Omnia Logo Screens, we recommend that you contact Telos / Omnia Customer Support for assistance. Please see the section entitled Obtaining Service on Page 111 for contact information.

## Obtaining Service

- Omnia Customer Support personnel are available in Cleveland, Ohio, USA, Monday through Friday between 9:00 A.M. and 6:00 P.M., Eastern Time. If outside the U.S.A., see below.
- Before contacting Omnia Customer Support, please have the serial number of the unit (located on a small barcode sticker on the rear panel in this format: 4700XXYYYY) and a description of the symptoms/problems ready for the technician.
- All units being returned to for service MUST have a Return Authorization (RA) number assigned to them first. Units that are returned without a RA number will experience delays in service.
- Return the Omnia in its original shipping carton. For best treatment, shipping the Omnia in its original factory box protects it as well as possible. Damage caused by improper packaging is not covered under your warranty!
- Loaner units are usually available on a first come, first served basis. Your Omnia Customer Support Engineer will assist you with the necessary arrangements

**Note: To ensure prompt service, the Return Authorization number must be written prominently on or near the shipping label on the box!**

## Via the World Wide Web

The Omnia Web site has a wide variety of information that may be useful for product support, applications information, software updates, etc. The URL is: <http://www.omniaaudio.com>.

## Via E-Mail

The customer service e-mail address for Omnia is: [support@omniaaudio.com](mailto:support@omniaaudio.com).

## Via Phone & Mail (USA and non-European Countries)

Customer service is available by telephone, Monday – Friday between 9:00 A.M. and 6:00 P.M., USA Eastern time zone.

**Phone:** +1.216.241.7225      **Fax:** +1.216. 241.4103

Shipping Information: \* Omnia Customer Service  
2101 Superior Avenue  
Cleveland, Ohio 44114 USA

## Via Phone & Mail for Europe

Service is available from the Omnia Europe office in Freising, Germany.

**Phone:** +49 8161 42467      **Fax:** +49 8161 42402

Shipping Information: \* Omnia Europe  
Johannstraße 6  
D-85354 Freising, Germany

# APPENDIX A

## CE Declaration of Conformity

Supplementary Information for our European Users



Declaration of Conformity

Application of Council Directives: 93/68/EEC (CE marking); 73/23/EEC (safety-low voltage directive); 89/336/EEC (electromagnetic compatibility).

Standards to which conformity is declared: EN50081-1, EN50082-1.

Manufacturer's Name: Omnia, TLS Corporation

Manufacturer's Address: 2101 Superior Avenue, Cleveland, Ohio, USA

Type of Equipment: Audio Processor

Model No.: Omnia-6

Serial No.: \_\_\_\_\_

Year of Manufacture: 2001

*I, the undersigned, hereby declare that the equipment specified above conforms to the above Directives and Standards.*

Place: Cleveland, OH USA 44114

Date: December 11, 2001

Signature: \_\_\_\_\_ (on file)

Full Name: Frank Foti

Position: President

### CE Mark Conformance

December 11, 2001

Omnia, TLS Corp.  
2101 Superior Avenue  
Cleveland, OH USA 44114

Supervision and summary by: \_\_\_\_\_

Frank Foti

### 1.0 Introduction

**1.1 Scope** This record is intended to document the Omnia audio processor conformance with Council Directives: 93/68/EEC (CE marking); 73/23/EEC (safety-low voltage directive); 89/336/EEC (electromagnetic compatibility).

Testing was conducted during the period DATE.

**1.2 Purpose** Testing was performed to evaluate safety, emissions, and immunity, conformance to enable CE marking.

**1.3 Conclusions** The Omnia audio processor was found to be compliant and CE marking was applied to the product.



## CE Mark Conformance, contd.

Conformity is declared to the standards: EN50081-1, EN50082-1.

### 2.0 HF Radiated Emissions

**2.1 Standards Applied** The unit was laboratory evaluated according to standard: EN50081-1 using Measurement Document: EN55022, Class B.

**2.2 Testing** The unit was tested and evaluated by: Smith Electronics \*

**2.3 Test Results** The unit was found to be in conformance for both radiated and line-conducted emissions.

### 3.0 Immunity

#### 3.1 Standards Applied

3.1.1 ESD Susceptibility Measurement Document: IEC 1000-4-2 (IEC 801-2). Immunity to static electricity.

3.1.2 Radiated Susceptibility – HF Electric Field Measurement Document: IEC1000-4-3 (IEC 801-3).

3.1.3 Conducted Susceptibility – Power Line Measurement Documents: Burst/Transients: IEC1000-4-4 (IEC 801-4) Surge: IEC1000-4-5 (IEC 801-5) Voltage fluctuations: IEC1000-4-1 (IEC 801-1)

#### 3.2 Testing

**3.2.1 ESD Immunity** The unit was tested and evaluated by: Smith Electronics \*

**3.2.2 Radiated Immunity – RF Electric Field** The unit was tested and evaluated by: Smith Electronics \*

**3.2.3 Conducted Immunity – Power Line** Testing to IEC801-4 was conducted by: Smith Electronics \*

\* Smith Electronics  
8200 Snowville Rd.  
Cleveland, OH 44141 (USA)



## CE Conformance

This device complies with the requirements of EEC Council Directives: 93/68/EEC (CE marking); 73/23/EEC (safety-low voltage directive); 89/336/EEC (electromagnetic compatibility).

Conformity is declared to the following standards: EN50081-1, EN50082-1.



**Lithium Battery Caution:** Danger of explosion if the lithium battery is incorrectly replaced. Replace only with the same or equivalent type recommended by the manufacturer. Dispose of used batteries according to the manufacturer's instructions.

## Use of Shielded Cables

In order to conform to the CE requirements for HF radiation, shielded cables should be used for the audio and data connections. For audio connections, the cable shield should be connected to the XLR shell.

# Appendix B:

## Audio Processing FAQ...

While the above section was written with the idea to aid in making processing adjustments, we're still aware that there are other processing desires and configurations that some users desire. The following is a list of Frequently Asked Questions compiled from our Omnia Customer Support database:

1. *How do I eliminate some softer passages on older recordings from sounding dull?*

This is easily done by reducing the *GATE* thresholds in the *HF* (Band-2) section of the two-band AGC. Set the gate levels to a value of "1" and this will allow the H band to increase gain in this part of the spectrum when there is low level of presence or high frequencies of older recordings. The only caveat is that this change may increase high frequency noise or hiss.

2. *What is the difference between running the AGC Release times fast, as compared to doing the same thing in the Limiter bands?*

The first thing to understand is that the AGC and Limiter sections are designed to do two totally different operations. The AGC section is working on the controlling the medium-term *average* level, whereas the Limiters are more concerned with the short-term *peak* levels. There's a reason for this, as well as why the AGC sections feed the limiter sections. To try and paint the picture, let's think of a funnel turned sideways, so that the wide end of the funnel is on the left side, and the narrow end is on the right. Now, let's feed wide dynamic range audio into that funnel.

As the audio is funneled down to a smaller dynamic range, different styles of processing are used to perform this. The AGC section is part of the initial funneling process, and it will be working on controlling the medium-term *average*, or the meatier part of the signal. Some folks refer to this as the RMS level. After initially funneling down the audio level, the next stage is the limiting section where the remaining short-term peaks are controlled. The last stage is the clipper, where any remaining uncontrolled signals are processed in a very aggressive manner. But in our discussion, we're only concerning ourselves with the AGC and Limiter sections.

When the release time function in the AGC section is increased, it will yield increased audio density to the following limiter section. This will build up perceived loudness, but it will be done in a more graceful manner. The audio will appear "fuller". This is a good section to adjust first when trying to build a bit more on-air density.

The release function in the Limiters, will do a bit of the same, but its side-effects are a bit more audible. Because the action of the limiters is generally faster than the AGC sections to begin with and the compression ratio is higher, an increase in release time will also raise the level of Intermodulation (IMD) distortion. This is why Omnia-5EX has AGC algorithms that are designed to carry quite a bit of the load for loudness processing. You can always drive the limiters harder if you wish, but it will be at the expense of that added *busy* sound due to the harder work that the limiters are doing.

3. *My station comes a lot of women listeners, so high frequency distortion must be kept to a minimum. How can I make sure that the high-end is truly “silky-soft?”*

Omnia-5EX naturally offers a *silky-smooth* high end, but there are a few areas when you can further tame the high frequencies if desired. Before explaining this, we wish to say that the rumor that women listeners don't like a bright high end may not be true! What they don't like is a *distorted* high end. There is a huge difference between the two. It's fine to have a nice bright high end, as long as it's clean!

Now regarding your question: Reduce the drive to the upper two bands of the Multiband Limiter section. Start with a reduction of 1.0dB in each band. Reset the Limiter *Thresholds* in both of these bands to “0.0”. This will help soften and tame the high frequencies.

4. *Does the Composite Clipper contaminate the Stereo Pilot or RDS/SCA spectrum?*

NO! One of the advancements that we introduced in Omnia-5EX is the ability to use composite clipping with *no effect* to the 19kHz pilot integrity. The composite clipper is designed into the stereo generator, and is implemented with a phase linear notch filter that has negligible overshoot (< 1% modulation). *After* we're finished with the clipping function, we insert the Stereo Pilot. In essence, we clean out the area for the pilot signal before inserting it. By doing so, all clipping artifacts are kept to a level @ -75dB below 100% modulation, or -55dB below the pilot level. This insures no interference to the pilot detection function in those radios that measure noise around the 19kHz region to decide when to activate the stereo blend function.

There is also a phase linear low-pass filter at 54kHz, used to remove harmonic content created by composite clipping. This ensures that RDS and SCA signals can be utilized without interference from the action of the composite clipper. This filter is a carry-over from the original-Omnia design, and that filter design was based upon an older product of ours known as *The Dividend*.

5. *What pre-processors would you suggest I put in front of my Omnia-5EX?*

Actually none! We don't wish to sound arrogant by saying this, but if you look closely at the different sections of the Omnia4.5, you'll notice that we've already designed it into the system in the form of a very effective broadband AGC. One possible exception to this is in the case of STL systems, where the Omnia-5EX will be located at the transmitter site, and you need something to protect the STL from being over-driven. In those cases, we know that the *Aphex Compellor* works extremely well. As of this writing, the only processing function that we don't yet offer for the Omnia-5EX is reverb. So, unless you desire that *Boss Jock* feel for a CHR station, where you need to operate a reverb in front of the Omnia, we feel that it should run *barefoot*.

6. *Why does the Omnia-5EX sound like it has so much more high end as compared to my old processor?*

This is due to two distinct design features in Omnia-5EX. The method we use to perform the upper limiter function, and where pre-emphasis is added into the system, both contribute to the Omnia-5EX's uncanny clarity. Both of these features are significant advantages present in all Omnia processors.

Let's first discuss our limiter methodology. Other processors usually employ a type of limiting algorithm known as *feedback control*. While this function does a very nice job of controlling the audio signal, it's done at the expense of high Intermodulation Distortion. Feedback algorithms are actually better suited for the lower

frequencies, where any added intermodulation distortion creates a 'warming effect' to the audio. When used at the higher frequencies, the sound of this algorithm type can be annoying, as it sounds much more *busy* or *squashed* sounding. The limiting algorithms in the upper two bands in Omnia-5EX use a *feed-forward* design. This algorithm type yields much lower distortion, and thus it offers a far smoother, more open, and silkier sound.

The second difference is due to where we insert pre-emphasis in our system. Instead of inserting it before the multiband limiting section, we do it *after* the limiters, right before the clipper. By doing this, the system does not have to keep smashing the upper frequencies in order to control the pre-emphasis energy. In contrast, the feedback method does this, and it results in a dense and squashed sounding high end.

This was one of the original methods used to manage the pre-emphasis energy, and it works, so one might wonder how we can insert the pre-emphasis *after* the limiters and not generate unwanted high frequency distortion in the following clipper. The answer is threefold:

First, the RMS based AGC sections don't allow an unnatural buildup of high frequencies. Second, we alter the limiter thresholds to best manage the required pre-emphasis boost. Third, our proprietary clipper can deeply and cleanly clip the high frequencies without generating annoying distortion. The result is that neither our limiters nor our clipper needs to work very hard to control modulation. This, along with our proprietary feed-forward limiter algorithms, allows the high end to be *open and airy* sounding, without sounding torn and harsh. This, by the way, is one of the secrets to what some users refer to as *That Omnia Sound!*

#### 7. *I'm looking for Bass Effect that has a lot more "muscle" to it. How can I create that?*

For starters, try the suggestions explained in the previous *Thunder Bass* section. If you are still looking for even more Bass, the following suggestions will add more *depth* and *power* to the low end:

- Reduce the *attack* time of *LF* (Band-1) of the two-band AGC section. This will yield more density to the *Bass Enhance* section.
- Increase the output of *LF* (Band-1) in the *MIXER* block located just before the *Bass Enhance*.
- Raise the Threshold in the *SLF* (Band-1) Limiter by 0.5dB. **NOTE:** Be careful, while you will notice more low end, some material with extremely deep low frequencies might sound distorted due to more clipping of the added Bass peak levels at the clipper.
- Raise the *Bass Clipper Threshold* in the *Clipper* sub-menu. Make changes in 0.5dB increments. **NOTE:** Be careful, while you will notice more low end, some material with extremely deep low frequencies to begin with, might sound distorted due to more clipping of the added Bass peak levels at the clipper.

#### 8. *How do I select the best preset for my format? In other words, if I am a Jazz station, should I always use Jazz?*

It needs to be pointed out, that the preset list is designed as a starting point. You make your adjustments from there. The preset names were chosen, more or less, as simple descriptions for what type of programming might be suitable for that preset. This does not mean that the *Jazz* preset can only be used with that type of programming. In most cases, Jazz music is perceived to have a sound that desires a *smooth and open* presentation, along with small amounts of *coloration*, i.e. equalization. Thus, that preset does not

offer heavy compression, or the *wall of sound* that a CHR (Top-40) station may desire. Quality and musicality are foremost.

Even with that being said, there's no reason why a Jazz station would not desire to use something a bit more aggressive, like the *Adult Contemp* preset, or if less processing is the goal, then the *Classical* setting would suffice.

In general, the names of the presets follow what the perception of that radio format might be. Following is a glossary to each preset name, and how it affects the processing:

- **RocknRoll:** This is the <default> preset. We suggest starting here for most installations. The settings here are *generalized* so that the processor offers a nice balance of competitive loudness, quality, and consistent spectral balance. When we think of the many different genres of Rock and Roll music, and the desire for decent dial-dominance, along with consistent EQ from song to song, this preset achieves this balance.
- **AdultContemp:** Basically this is the *RocknRoll* preset, but scaled down. This offers moderate loudness, and increased quality, due to reduced levels of processing. This is a good tradeoff, when loudness is not the last word.
- **Chr:** This preset kicks things up a notch, or two, from the *RocknRoll* setting. A bit more aggressive, along with more *coloration*, this preset should be chosen when dial-dominance is desired. There is a nice lift to the Bass and Treble ranges when using this preset.
- **Chr Dense:** Similar to the *Chr* preset but with more limiter action for a tighter, denser sound.
- **Chr Lite:** Think of this has a halfway stop between *Chr* and *RocknRoll*. A great compromise setting for when *Chr* is too aggressive and *RocknRoll* is not aggressive enough.
- **Chr Phat:** This preset has all the loudness of the CHR preset along with extra “phatness” and “girth” added for good measure. Also works well on Urban formats.
- **Classical:** This is straightforward. When quality is the utmost desire. This preset offers a *flat*, unprocessed sound with minimal *coloration*. It is designed to keep the on-air sound as close as possible to the source material.
- **Country:** Think of this has a halfway stop between *RocknRoll* and *AdultContemp*. This preset takes into consideration that Country music usually offers an emphasis to string instruments like guitars; the processing is set to accommodate that. The Bass Boost is set for a *warmer* sound by increasing the upper-bass, instead of the *Thump-Bass*. Vocals stand out, along with clarity to string instruments.
- **Jazz:** Jazz music is perceived to have a sound that desires a *smooth and open* presentation, along with small amounts of dynamic equalization. This preset does not offer the heavy compression or *wall of sound* that a CHR (Top-40) station may desire. Quality and musicality are foremost.
- **Oldies:** Where were you in the 1970's when that *Boss Jock* sound was king!! This preset offers more compression and density which yields good spectral balance. Most *OLDIES* formats play music that needs help in the warmth and clarity. The processing is set to enhance those areas.
- **Phatso:** Even more *Phatness!*

- **Smooth:** Start here for Soft AC, Smooth Jazz and even Rock formats where some loudness is desired but smoothness and consistency is valued above all.
- **Talk:** This preset will utilize more of the AGC GATING functions so that there are not needless amounts of gain being added during pauses in speech. The *EQ* settings are set to enhance intelligibility, and reduce the false bass boost that can occur when multiband processing is used for this type of programming. This can also be used for sports programming.

9. *Please describe the tradeoff between the main clipper and the composite clipper. When would I use one or the other? When would I use both? If I used both, what would be the amounts of each?*

The Main Clipper in Omnia-5EX is quite powerful!! All of the presets operate with a moderate amount and the Composite Clipper is defaulted to the *0.0* or *OFF* position. In most cases, you will not need the Composite Clipper. The tradeoff between the two clippers is relative to the *texture* of the audio. The Main Clipper employs distortion control to reduce the perceived effects of the clipping process. Whereas, the Composite Clipper creates a sort of *sparkle*, and tightening of Bass to it's effect. There's also an illusion of added stereo, due to the clipping process in the mpx spectrum.

When ultimate, moment-to-moment loudness is a must, then adding some composite clipping to your preset will do the trick. How much? Well, start off with no more than 1.0dB, and work from there. If too much is applied, audible distortion will result. When using the Composite Clipper, begin with the Main Clipper set to the normal defaulted operating level.

10. *What is clipper silk? How do I adjust it? What difference does it make in the sound of my station?*

This is a feature that debuted in the Omnia-6. *Clipper Silk* is an additional distortion-controlling network that you can adjust. It is designed to further suppress Intermodulation Distortion (IMD) that can be caused by the main clipping process. This is especially noticeable on voice, string instruments, or sustained vocal passages that have an underlying bass content present. When the adjustment is set to *0*, then the main clipper emulates the operation of the clipping system that was used in the original-Omnia processor. As the adjustment is advanced, it increases the operation of the added distortion reduction network. In some very extreme cases, there may be a slight reduction in the upper high frequencies due to its operation. But this effect is quite subtle, to say the least.



## Appendix D

### Front Panel Software Upgrade (user interface)

The Omnia's front panel software can be updated by downloading new code to it over the Ethernet connection. To use this feature, you must first have the proper front panel software update (.upd) file. This file can be obtained from <http://www.omniaaudio.com/support/updates.htm>. Check back often to ensure that you have the benefit of the latest updates and features.

To install the updates:

1. Download the latest front panel update from <http://www.omniaaudio.com/support/updates.htm>. We recommend downloading the file to a new folder on your PC's desktop for convenient access during the procedure.
2. Configure Omnia Remote Control for connection to the Omnia over a network. Note that if you don't have a network, you can still use Ethernet if you use a crossover cable between the PC and Omnia. Such cables can be obtained from many computer products stores.
3. Connect to the Omnia over Ethernet.
4. Using the Options menu, navigate to the Upgrade Front Panel menu option. When you select it, an Open File dialog box will appear. Point the program to the folder on your PC where you downloaded the file.
5. Select the 'omn6hd.upd' file and click the Open button. A message box will appear, detailing the process of downloading the file to the front panel. The update process can take several minutes, and may appear to be stuck at some points in the process. This is normal! Therefore do not interrupt the update! When the update is finished, a new message box will appear stating "Upgrade Successful".
6. It will now be necessary to reboot the front panel using the menu option \System\Network\Reboot Display feature in order to load and run the new software that was just downloaded. This may be done immediately after downloading the update, or at a more convenient time if necessary. Rebooting the front panel should not interrupt the audio.

### Rear Panel Software Upgrade (DSP code)

To upgrade the DSP code portions of the Omnia.

DSP software updates are always free of charge and can be obtained by contacting your dealer or Omnia Customer Support at:

Omnia USA

2101 Superior Avenue

Cleveland, Ohio 44114 USA

TEL: +1 216.241.7225 • FAX: +1 216.241.4103

Email: [support@omniaaudio.com](mailto:support@omniaaudio.com)

Omnia Europe

Johannistrabe 6 D-85354

Freising, Germany

TEL: +49 8161 42467 • FAX +49 8161 42402

Email: [europe@omniaaudio.com](mailto:europe@omniaaudio.com)

<http://www.omniaaudio.com>

**Portions of the embedded software are distributed under the following terms:**

*Omnia-5EX Use and Operation Manual – V: 1.1*



## GNU GENERAL PUBLIC LICENSE

Version 2, June 1991

Copyright © 1989, 1991 Free Software Foundation, Inc.

59 Temple Place - Suite 330, Boston, MA

02111-1307, USA.

Everyone is permitted to copy and distribute verbatim copies of this license document, but changing it is not allowed.

### Preamble

The licenses for most software are designed to take away your freedom to share and change it. By contrast, the GNU General Public License is intended to guarantee your freedom to share and change free software—to make sure the software is free for all its users. This General Public License applies to most of the Free Software

Foundation’s software and to any other program whose authors commit to using it. (Some other Free Software Foundation software is covered by the GNU Library General Public License instead.) You can apply it to your programs, too.

When we speak of free software, we are referring to freedom, not price. Our General Public Licenses are designed to make sure that you have the freedom to distribute copies of free software (and charge for this service if you wish), that you receive source code or can get it if you want it, that you can change the software or use pieces of it in new free programs; and that you know you can do these things.

To protect your rights, we need to make restrictions that forbid anyone to deny you these rights or to ask you to surrender the rights. These restrictions translate to certain responsibilities for you if you distribute copies of the software, or if you modify it. For example, if you distribute copies of such a program, whether gratis or for a fee, you must give the recipients all the rights that you have. You must make sure that they, too, receive or can get the source code. And you must show them these terms so they know their rights.

We protect your rights with two steps: (1) copyright the software, and (2) offer you this license which gives you legal permission to copy, distribute and/or modify the software.

Also, for each author’s protection and ours, we want to make certain that everyone understands that there is no warranty for this free software. If the software is modified by someone else and passed on, we want its recipients to know that what they have is not the original, so that any problems introduced by others will not reflect on the original authors’ reputations.

Finally, any free program is threatened constantly by software patents. We wish to avoid the danger that redistributors of a free program will individually obtain patent licenses, in effect making the program proprietary. To prevent this, we have made it clear that any patent must be licensed for everyone’s free use or not licensed at all.

The precise terms and conditions for copying, distribution and modification follow.

## GNU GENERAL PUBLIC LICENSE

### TERMS AND CONDITIONS FOR COPYING, DISTRIBUTION AND MODIFICATION

0. This License applies to any program or other work which contains a notice placed by the copyright holder saying it may be distributed under the terms of this General Public License. The “Program”, below, refers to any such program or work, and a “work based on the Program” means either the Program or any derivative work under copyright law: that is to say, a work containing the Program or a portion of it, either verbatim or with modifications and/or translated into another language. (Hereinafter, translation is included without limitation in the term “modification”.) Each licensee is addressed as “you”. Activities other than copying, distribution and modification are not covered by this License; they are outside its scope. The act of running the Program is not restricted, and the output from the Program is covered only if its contents constitute a work based on the Program (independent of having been made by running the Program). Whether that is true depends on what the Program does.

1. You may copy and distribute verbatim copies of the Program’s source code as you receive it, in any medium, provided that you conspicuously and appropriately publish on each copy an appropriate copyright notice and disclaimer of warranty; keep intact all the notices that refer to this License and to the absence of any warranty; and give any other recipients of the Program a copy of this License along with the Program.

You may charge a fee for the physical act of transferring a copy, and you may at your option offer warranty protection in exchange for a fee.

2. You may modify your copy or copies of the Program or any portion of it, thus forming a work based on the Program, and copy and distribute such modifications or work under the terms of Section 1 above, provided that you also meet all of these conditions:

- a) You must cause the modified files to carry prominent notices stating that you changed the files and the date of any change.
- b) You must cause any work that you distribute or publish, that in whole or in part contains or is derived from the Program or any part thereof, to be licensed as a whole at no charge to all third parties under the terms of this License.
- c) If the modified program normally reads commands interactively when run, you must cause it, when started running for such interactive use in the most ordinary way, to print or display an announcement including an appropriate copyright notice and a notice that there is no warranty (or else, saying that you provide a warranty) and that users may redistribute the program under these conditions, and telling the user how to view a copy of this License. (Exception: if the Program itself is interactive but does not normally print such an announcement, your work based on the Program is not required to print an announcement.)

These requirements apply to the modified work as a whole. If identifiable sections of that work are not derived from the Program, and can be reasonably considered independent and separate works in themselves, then this License, and its terms, do not apply to those sections when you distribute them as separate works. But when you distribute the same sections as part of a whole which is a work based on the Program, the distribution of the whole must be on the terms of this License, whose permissions for other licensees extend to the entire whole, and thus to each and every part regardless of who wrote it. Thus, it is not the intent of this section to claim rights or contest your rights to work written entirely by you; rather, the intent is to exercise the right to control the distribution of derivative or collective works based on the Program.

In addition, mere aggregation of another work not based on the Program with the Program (or with a work based on the Program) on a volume of a storage or distribution medium does not bring the other work under the scope of this License.

3. You may copy and distribute the Program (or a work based on it, under Section 2) in object code or executable form under the terms of Sections 1 and 2 above provided that you also do one of the following:

a) Accompany it with the complete corresponding machine-readable source code, which must be distributed under the terms of Sections 1 and 2 above on a medium customarily used for software interchange; or,

b) Accompany it with a written offer, valid for at least three years, to give any third party, for a charge no more than your cost of physically performing source distribution, a complete machine-readable copy of the corresponding source code, to be distributed under the terms of Sections 1 and 2 above on a medium customarily used for software interchange; or,

c) Accompany it with the information you received as to the offer to distribute corresponding source code. (This alternative is allowed only for noncommercial distribution and only if you received the program in object code or executable form with such an offer, in accord with Subsection b above.)

The source code for a work means the preferred form of the work for making modifications to it. For an executable work, complete source code means all the source code for all modules it contains, plus any associated interface definition files, plus the scripts used to control compilation and installation of the executable. However, as a special exception, the source code distributed need not include anything that is normally distributed (in either source or binary form) with the major components (compiler, kernel, and so on) of the operating system on which the executable runs, unless that component itself accompanies the executable. If distribution of executable or object code is made by offering access to copy from a designated place, then offering equivalent access to copy the source code from the same place counts as distribution of the source code, even though third parties are not compelled to copy the source along with the object code.

4. You may not copy, modify, sublicense, or distribute the Program except as expressly provided under this License. Any attempt otherwise to copy, modify, sublicense or distribute the Program is void, and will automatically terminate your rights under this License. However, parties who have received copies, or rights, from you under this License will not have their licenses terminated so long as such parties remain in full compliance.

5. You are not required to accept this License, since you have not signed it. However, nothing else grants you permission to modify or distribute the Program or its derivative works. These actions are prohibited by law if you do not accept this License. Therefore, by modifying or distributing the Program (or any work based on the Program), you indicate your acceptance of this License to do so, and all its terms and conditions for copying, distributing or modifying the Program or works based on it.

6. Each time you redistribute the Program (or any work based on the Program), the recipient automatically receives a license from the original licensor to copy, distribute or modify the Program subject to these terms and conditions. You may not impose any further restrictions on the recipients' exercise of the rights granted herein. You are not responsible for enforcing compliance by third parties to this License.

7. If, as a consequence of a court judgment or allegation of patent infringement or for any other reason (not limited to patent issues), conditions are imposed on you (whether by court order, agreement or otherwise) that contradict the conditions of this License, they do not excuse you from the conditions of this License. If you cannot distribute so as to satisfy simultaneously your obligations under this License and any other pertinent obligations, then as a consequence you may not distribute the Program at all. For example, if a patent license would not permit royalty-free redistribution of the Program by all those who receive copies directly or indirectly through you, then the only way you could satisfy both it and this License would be to refrain entirely from distribution of the Program.

If any portion of this section is held invalid or unenforceable under any particular circumstance, the balance of the section is intended to apply and the section as a whole is intended to apply in other circumstances.

It is not the purpose of this section to induce you to infringe any patents or other property right claims or to contest validity of any such claims; this section has the sole purpose of protecting the integrity of the free software distribution system, which is implemented by public license practices. Many people have made generous contributions to the wide range of software distributed through that system in reliance on consistent application of that system; it is up to the author/donor to decide if he or she is willing to distribute software through any other system and a licensee cannot impose that choice. This section is intended to make thoroughly clear what is believed to be a consequence of the rest of this License.

8. If the distribution and/or use of the Program is restricted in certain countries either by patents or by copyrighted interfaces, the original copyright holder who places the Program under this License may add an explicit geographical distribution limitation excluding those countries, so that distribution is permitted only in or among countries not thus excluded. In such case, this License incorporates the limitation as if written in the body of this License.

9. The Free Software Foundation may publish revised and/or new versions of the General Public License from time to time. Such new versions will be similar in spirit to the present version, but may differ in detail to address new problems or concerns.

Each version is given a distinguishing version number. If the Program specifies a version number of this License which applies to it and “any later version”, you have the option of following the terms and conditions either of that version or of any later version published by the Free Software Foundation. If the Program does not specify a version number of this License, you may choose any version ever published by the Free Software Foundation.

10. If you wish to incorporate parts of the Program into other free programs whose distribution conditions are different, write to the author to ask for permission. For software which is copyrighted by the Free Software Foundation, write to the Free Software Foundation; we sometimes make exceptions for this. Our decision will be guided by the two goals of preserving the free status of all derivatives of our free software and of promoting the sharing and reuse of software generally.

#### NO WARRANTY

11. BECAUSE THE PROGRAM IS LICENSED FREE OF CHARGE, THERE IS NO WARRANTY FOR THE PROGRAM, TO THE EXTENT PERMITTED BY APPLICABLE LAW. EXCEPT WHEN OTHERWISE STATED IN WRITING THE COPYRIGHT HOLDERS AND/OR OTHER PARTIES PROVIDE THE PROGRAM “AS IS” WITHOUT WARRANTY OF ANY KIND, EITHER EXPRESSED OR IMPLIED, INCLUDING, BUT NOT LIMITED TO, THE IMPLIED WARRANTIES OF MERCHANTABILITY AND FITNESS FOR A PARTICULAR PURPOSE. THE ENTIRE RISK AS TO THE QUALITY AND PERFORMANCE OF THE PROGRAM IS WITH YOU. SHOULD THE PROGRAM PROVE DEFECTIVE, YOU ASSUME THE COST OF ALL NECESSARY SERVICING, REPAIR OR CORRECTION.

12. IN NO EVENT UNLESS REQUIRED BY APPLICABLE LAW OR AGREED TO IN WRITING WILL ANY COPYRIGHT HOLDER, OR ANY OTHER PARTY WHO MAY MODIFY AND/OR REDISTRIBUTE THE PROGRAM AS PERMITTED ABOVE, BE LIABLE TO YOU FOR DAMAGES, INCLUDING ANY GENERAL, SPECIAL, INCIDENTAL OR CONSEQUENTIAL DAMAGES ARISING OUT OF THE USE OR INABILITY TO USE THE PROGRAM (INCLUDING BUT NOT LIMITED TO LOSS OF DATA OR DATA BEING RENDERED INACCURATE OR LOSSES SUSTAINED BY YOU OR THIRD PARTIES OR A FAILURE OF THE PROGRAM TO OPERATE WITH ANY OTHER PROGRAMS), EVEN IF SUCH HOLDER OR OTHER PARTY HAS BEEN ADVISED OF THE POSSIBILITY OF SUCH DAMAGES.

#### END OF TERMS AND CONDITIONS

#### Appendix: How to Apply These Terms to Your New Programs

If you develop a new program, and you want it to be of the greatest possible use to the public, the best way to achieve this is to make it free software which everyone can redistribute and change under these terms.

To do so, attach the following notices to the program. It is safest to attach them to the start of each source file to most effectively convey the exclusion of warranty; and each file should have at least the “copyright” line and a pointer to where the full notice is found. <one line to give the program’s name and a brief idea of what it does.>

Copyright © 19yy <name of author>

This program is free software; you can redistribute it and/or modify it under the terms of the GNU General Public License as published by the Free Software Foundation; either version 2 of the License, or (at your option) any later version.

This program is distributed in the hope that it will be useful, but WITHOUT ANY WARRANTY; without even the implied warranty of MERCHANTABILITY or FITNESS FOR A PARTICULAR PURPOSE. See the GNU General Public License for more details.

You should have received a copy of the GNU General Public License along with this program; if not, write to the Free Software Foundation, Inc., 59 Temple Place - Suite 330, Boston, MA 02111-1307, USA.

Also add information on how to contact you by electronic and paper mail.

If the program is interactive, make it output a short notice like this when it starts in an interactive mode:

Gnomovision version 69, Copyright © 19yy name of author

Gnomovision comes with ABSOLUTELY NO WARRANTY; for details type ‘show w’.

This is free software, and you are welcome to redistribute it under certain conditions; type ‘show c’ for details.

The hypothetical commands ‘show w’ and ‘show c’ should show the appropriate parts of the General Public License. Of course, the commands you use may be called something other than ‘show w’ and ‘show c’; they could even be mouse-clicks or menu items—whatever suits your program.

You should also get your employer (if you work as a programmer) or your school, if any, to sign a “copyright disclaimer” for the program, if necessary. Here is a sample; alter the names:

Yoyodyne, Inc., hereby disclaims all copyright interest in the program ‘Gnomovision’ (which makes passes at compilers) written by James Hacker.

<signature of Ty Coon>, 1 April 1989

Ty Coon, President of Vice

This General Public License does not permit incorporating your program into proprietary programs. If your program is a subroutine library, you may consider it more useful to permit linking proprietary applications with the library. If this is what you want to do, use the GNU Library General Public License instead of this License.